



Alexander Wiegand
Chairman and CEO, WIKA

About us

The WIKA Group is a global market leader in pressure and temperature measurement. The company also sets the standard in the measurement of level, force and flow, and in calibration technology.

The broad portfolio of high-precision instruments, IIoT solutions and comprehensive services makes WIKA a strong and reliable partner for all the requirements of industrial measurement technology.

The family-run business, founded in 1946, has a global presence with 11,200 employees. This includes our own subsidiaries, production sites and development departments, such as the Innovation Center in Klingenberg. There alone, over 100 engineers work on smart sensing solutions that provide answers to global challenges. WIKA's unique experience and know-how make sensing technology smarter, add more value and prepare it for a sustainable future:

Smart in sensing.

Contents

You will find more information on our industry-specific products on page 118.

PRESSURE

Display	Pressure gauges	4
	Digital pressure gauges	12
Transmit	Process transmitters	14
	Pressure sensors	16
	Pressure gauges with output signal	19
Switch	Contact pressure gauges	21
	Pressure switches	23
Additional products and accessories	Diaphragm seal systems	26
	Valves and mounting accessories	27
	Electrical accessories	29

TEMPERATURE

Display	Dial thermometers	30
	Digital indicators	34
Transmit + Record	Thermocouples	36
	Resistance thermometers	42
	Temperature transmitters	47
Switch	Temperature switches	48
	Thermometers with switch contacts	49
	Temperature controllers	50
	Accessories	51
Additional products and accessories	Thermowells / Protection tubes	52

LEVEL

Display	Bypass level indicators	54
	External chambers	57
	Glass level gauges	58
Transmit	Submersible pressure sensors	60
	Continuous measurement with float	61
Switch	Float switches	66
	Optoelectronic switches	70
	Vibrating level switches	73

FORCE

Compression force transducers	74
Tension/Compression force transducers	75
Bending/Shear beams	76
Load cells	77
Load pins, tension links	78
Ring force transducers	79
Special force transducers	80
Electronics	81

FLOW

Primary flow elements	82
Flow switches	89

IloT SOLUTIONS

IloT service	90
IloT products	92

CALIBRATION

Pressure	Digital pressure gauges	95
	Hand-helds, calibrators	96
	Precision pressure measuring instruments	97
	Pressure controllers	98
	Pressure balances	100
	Calibration software	103
Pressure generation		104
Temperature	Reference thermometers	106
	Hand-helds	107
	Calibration baths	108
	Portable temperature calibrators	109
	Resistance thermometry bridges	110
	Standard reference resistors, AC/DC	111
	Additional products and accessories	112
Engineered solutions	113	

SERVICE

Service	116
---------	-----

Bourdon tube pressure gauges

Copper alloy

These pressure gauges are suitable for liquid and gaseous media, so long as they are not highly viscous or crystallising and do not attack copper alloy parts. The scale ranges cover pressures from 0.6 ... 1,000 bar. Many of these instruments are manufactured in accordance with the European standard EN 837-1.



111.10, 111.12
Standard version

Nominal size	27, 40, 50, 63, 80, 100, 160 mm
Scale range	-1 ... 0 to 0 ... 400 bar
Accuracy class	2.5, 1.6 optional NS 27: 4.0
Data sheet	PM 01.01, PM 01.17



111.11
Welding gauge ISO 5171

Nominal size	40, 50, 63 mm
Scale range	0 ... 0.6 to 0 ... 400 bar
Accuracy class	2.5
Data sheet	PM 01.03



111.16, 111.26
Panel mounting series ISO 5171

Nominal size	40, 50, 63 mm, model 111.26 also 80 mm
Scale range	-1 ... 0 to 0 ... 400 bar
Accuracy class	2.5, 1.6 optional
Data sheet	PM 01.10



113.13
Plastic case, liquid filling

Nominal size	40, 50, 63 mm
Scale range	-1 ... 0 to 0 ... 400 bar
Accuracy class	2.5
Data sheet	PM 01.04



214.11
Edgewise panel design

Nominal size	96 x 96, 72 x 72
Scale range	<ul style="list-style-type: none"> ■ NS 96 x 96: 0 ... 0.6 to 0 ... 1,000 bar ■ NS 72 x 72: 0 ... 0.6 to 0 ... 400 bar
Accuracy class	1.6, 1.0
Data sheet	PM 02.07



PG81, PG91
DirectDrive pressure gauge

Nominal size	36, 41 mm
Scale range	0 ... 6 to 0 ... 450 bar
Accuracy class	4.0
Data sheet	PM 01.50



212.20
Stainless steel case

Nominal size	100, 160 mm
Scale range	-1 ... 0 to 0 ... 1,000 bar
Accuracy class	1.0
Data sheet	PM 02.01



213.40
Heavy-duty version,
case filling

Nominal size	63, 80, 100 mm
Scale range	-1 ... 0 to 0 ... 1,000 bar
Accuracy class	1.0, 1.6 (NS 63, 80)
Data sheet	PM 02.06



113.53, 213.53
Stainless steel case,
case filling

Nominal size	<ul style="list-style-type: none"> ■ 113.53: 40, 80, 100 mm ■ 213.53: 50, 63, 100 mm
Scale range	-1 ... 0 to 0 ... 600 bar (213.53: to 1,000 bar)
Accuracy class	113.53: 1.6 (NS 80, 100), 2.5 213.53: 1.0 (NS 100), 1.6 (NS 50, 63)
Data sheet	PM 01.08, PM 02.12

Thermomanometers



MFT
With capillaries, for pressure and
temperature measurement

Nominal size	40, 42, 52 mm
Scale range	<ul style="list-style-type: none"> ■ Pressure: 0 ... 4 bar ■ Temperature: 0 ... 120 °C
Accuracy class	<ul style="list-style-type: none"> ■ Pressure: 2.5 (EN 837-1) ■ Temperature: 2.5
Data sheet	PM 01.20



THM10
Eco version, for pressure and
temperature measurement

Nominal size	63, 80 mm
Scale range	<ul style="list-style-type: none"> ■ Pressure: 0 ... 4 to 0 ... 10 bar ■ Temperature: 0 ... 120 °C
Connection location	Lower mount or back mount
Accuracy class	<ul style="list-style-type: none"> ■ Pressure: 2.5 (EN 837-1) ■ Temperature: 2 (EN 13190)
Data sheet	PM 01.24



100.02
For pressure and
temperature measurement

Nominal size	63, 80 mm
Scale range	<ul style="list-style-type: none"> ■ Pressure: 0 ... 1 to 0 ... 16 bar ■ Temperature: 0 ... 100 to 0 ... 150 °C
Connection location	Lower mount or back mount
Accuracy class	<ul style="list-style-type: none"> ■ Pressure: 2.5 (EN 837-1) ■ Temperature: ±2.5
Data sheet	PM 01.23

Bourdon tube pressure gauges

Stainless steel

The wetted parts of these pressure gauges are manufactured entirely from stainless steel. Thus they are suitable for gaseous and liquid aggressive media that are not highly viscous or crystallising, also in aggressive environments. They are suitable for scale ranges from 0 ... 0.6 to 0 ... 7,000 bar.

Depending on the pressure range and the instrument model, overload safety of to a maximum of 5 x full scale value is possible. To this point, the measurement accuracy is maintained. Liquid filling the case ensures precise readability, even with high dynamic pressure loads and vibrations.



131.11
Compact version

Nominal size	40, 50, 63 mm
Scale range	<ul style="list-style-type: none"> ■ NS 40, 50: 0 ... 1 to 0 ... 600 bar ■ NS 63: 0 ... 1 to 0 ... 1,000 bar
Accuracy class	2.5
Ingress protection	IP54
Data sheet	PM 01.05



232.50, 233.50
For the process industry,
standard version

Nominal size	63, 100, 160 mm
Scale range	<ul style="list-style-type: none"> ■ NS 63: 0 ... 1 to 0 ... 1,000 bar ■ NS 100: 0 ... 0.6 to 0 ... 1,000 bar ■ NS 160: 0 ... 0.6 to 0 ... 1,600 bar
Accuracy class	1.0 (NS 100, 160), 1.6 (NS 63)
Ingress protection	IP65
Data sheet	PM 02.02



232.30, 233.30
For the process industry,
safety version

Nominal size	63, 100, 160 mm
Scale range	<ul style="list-style-type: none"> ■ NS 63: 0 ... 1 to 0 ... 1,000 bar ■ NS 100: 0 ... 0.6 to 0 ... 1,000 bar ■ NS 160: 0 ... 0.6 to 0 ... 1,600 bar
Accuracy class	1.0 (NS 100, 160), 1.6 (NS 63)
Ingress protection	IP65
Data sheet	PM 02.04



232.36, 233.36
High overload safety to 4 times
the full scale value, safety
version

Nominal size	100, 160 mm
Scale range	0 ... 0.6 to 0 ... 40 bar
Overload safety	Up to 4 times the measuring range
Accuracy class	1.0
Data sheet	PM 02.15



232.34, 233.34
Process pressure gauge
XSEL[®], safety version per
ASME B40.100

Nominal size	4 1/2", 6"
Scale range	0 ... 0.6 bar to 0 ... 2,000 bar
Accuracy class	Grade 2A
Ingress protection	IP54, with liquid filling IP65
Data sheet	PM 02.10

Test gauges

For highest accuracy

Depending on the instrument model, accuracies of 0.1, 0.25 or 0.6 % of full scale value can be measured.

The pressure ranges cover from 0 ... 6 mbar to 0 ... 1,600 bar and are suitable for calibration tasks. For each of the pressure gauges specified here, a DAkkS calibration certificate can be provided.



312.20

Copper alloy,
class 0.6

Nominal size	160 mm
Scale range	0 ... 0.6 to 0 ... 600 bar
Accuracy class	0.6
Ingress protection	IP54
Data sheet	PM 03.01



332.50, 333.50

Stainless steel, standard
version, class 0.6

Nominal size	160 mm
Scale range	0 ... 0.6 to 0 ... 1,600 bar
Accuracy class	0.6
Ingress protection	IP65
Data sheet	PM 03.06



332.30, 333.30

Stainless steel, safety
version, class 0.6

Nominal size	160 mm
Scale range	0 ... 0.6 to 0 ... 1,600 bar
Accuracy class	0.6
Ingress protection	IP65
Data sheet	PM 03.05



342.11

From class 0.1,
with transport case and
acceptance test certificate

Nominal size	250 mm
Scale range	0 ... 1 to 0 ... 1,600 bar
Accuracy class	<ul style="list-style-type: none"> ■ 0.1 for scale ranges < 400 bar ■ 0.25 for scale ranges ≥ 400 bar
Ingress protection	IP54
Data sheet	PM 03.03



610.20, 630.20

For low pressure ranges from
10 mbar, class 0.6

Nominal size	160 mm
Scale range	0 ... 10 to 0 ... 600 mbar
Accuracy class	0.6
Ingress protection	IP54
Data sheet	PM 06.09

Diaphragm pressure gauges

The application areas for diaphragm pressure gauges are very versatile. They are the specialists in the process industry when it comes to critical measuring requirements such as with highly corrosive or viscous media or when it comes to low pressures and high overload.

The scale ranges are from as low as 0 ... 16 mbar to typically 0 ... 25 to 0 ... 40 bar. Depending on the pressure range and the instrument model, overload safety of 3 x or 5 x full scale value is possible as standard.

For special designs, an overload safety of up to 400 bar is possible, with the measurement accuracy maintained.

Diaphragm pressure gauges are even suitable for highly viscous or contaminated media by using an open connecting flange (per DIN/ASME). For measuring particularly aggressive media, the complete wetted surface can be lined with a large selection of special materials (e.g. PTFE, Hastelloy, tantalum, and many more).



422.12, 423.12
Grey cast iron case

Nominal size	100, 160 mm
Scale range	0 ... 16 mbar to 0 ... 40 bar
Accuracy class	1.6
Ingress protection	IP54, with liquid filling IP65
Data sheet	PM 04.02



**432.50, 433.50,
432.30, 433.30,
452.50, 453.50,
452.30, 453.30**

For the process industry, high overload safety up to 10 times the full scale value, max. 40 bar

Nominal size	100, 160 mm
Scale range	0 ... 16 mbar to 0 ... 25 bar
Accuracy class	1.6
Ingress protection	IP54, with liquid filling IP65
Data sheet	PM 04.03



**432.56, 433.56,
432.36, 433.36**

For the process industry, high overload safety to 40, 100 or 400 bar

Nominal size	100, 160 mm
Scale range	0 ... 16 mbar to 0 ... 40 bar
Accuracy class	1.6
Ingress protection	IP54, with liquid filling IP65
Data sheet	PM 04.07

Capsule pressure gauges

For very low pressures

These measuring instruments are particularly suited to gaseous media. The scale ranges are between 0 ... 2.5 mbar and 0 ... 1,000 mbar in accuracy classes from 0.1 to 2.5. Capsule pressure gauges consist of two circular, corrugated diaphragms, joined together around the edge with a pressure-tight seal. Overload protection is possible in certain cases.

These capsule pressure gauges are used mainly in medical, vacuum, environmental and laboratory technology for contents measurement and filter monitoring.



611.10
Standard version

Nominal size	50, 63 mm
Scale range	0 ... 25 to 0 ... 600 mbar
Accuracy class	1.6
Ingress protection	IP54
Data sheet	PM 06.01



611.13
Plastic case

Nominal size	50, 63 mm
Scale range	0 ... 60 to 0 ... 600 mbar
Accuracy class	2.5
Ingress protection	IP53
Data sheet	PM 06.12



612.20
Stainless steel case

Nominal size	63, 100, 160 mm
Scale range	0 ... 6 to 0 ... 600 mbar
Accuracy class	1.6
Ingress protection	IP54
Data sheet	PM 06.02



614.11, 634.11
Edgewise panel design

Nominal size	72 x 72, 96 x 96, 144 x 144, 144 x 72 mm
Scale range	<ul style="list-style-type: none"> ■ NS 72 x 72: 0 ... 25 to 0 ... 600 mbar ■ NS 96 x 96: 0 ... 10 to 0 ... 600 mbar ■ NS 144 x 144: 0 ... 6 to 0 ... 600 mbar ■ NS 144 x 72: 0 ... 4 to 0 ... 600 mbar
Accuracy class	1.6
Data sheet	PM 06.05



632.50
For the process industry

Nominal size	63, 100, 160 mm
Scale range	<ul style="list-style-type: none"> ■ NS 63: 0 ... 40 to 0 ... 600 mbar ■ NS 100: 0 ... 16 to 0 ... 600 mbar ■ NS 160: 0 ... 2.5 to 0 ... 600 mbar
Accuracy class	1.6
Ingress protection	IP54, with liquid filling IP65
Data sheet	PM 06.03



632.51
For the process industry,
high overload safety

Nominal size	100, 160 mm
Scale range	0 ... 2.5 mbar to 0 ... 100 mbar
Accuracy class	1.6
Ingress protection	IP54
Data sheet	PM 06.06



Differential pressure gauges

Differential pressure gauges work with a wide range of pressure elements. With this variety, measuring ranges from 0 ... 0.5 mbar to 0 ... 1,000 bar and static overlay pressures up to 400 bar are possible.

These measuring instruments monitor:

- the pollution degree in filter systems
- the level in closed containers
- the overpressure in clean rooms
- the flow of gaseous and liquid media
- and they control pumping plants



700.01, 700.02

With magnetic piston or with magnetic piston and separating diaphragm

Nominal size	80 mm
Scale range	<ul style="list-style-type: none"> ■ 700.01: 0 ... 400 mbar to 0 ... 10 bar ■ 700.02: 0 ... 160 mbar to 0 ... 2.5 bar
Accuracy class	<ul style="list-style-type: none"> ■ 700.01: ±3 % ■ 700.02: ±5 % with increasing differential pressure
Ingress protection	IP54
Data sheet	PM 07.14



711.12, 731.12

With parallel entry, copper alloy or stainless steel

Nominal size	100, 160 mm
Scale range	0 ... 0.6 to 0 ... 1,000 bar
Accuracy class	1.6
Ingress protection	IP33
Data sheet	PM 07.02



DPG40

With integrated working pressure indication (DELTA-plus)

Nominal size	100 mm
Scale range	0 ... 0.16 to 0 ... 10 bar
Accuracy class	2.5
Ingress protection	IP65
Data sheet	PM 07.20



716.11, 736.11

For very low differential pressures from 2.5 mbar, copper alloy or stainless steel

Nominal size	100, 160 mm
Scale range	<ul style="list-style-type: none"> ■ NS 100: 0 ... 10 to 0 ... 250 mbar ■ NS 160: 0 ... 2.5 to 0 ... 250 mbar
Accuracy class	1.6
Ingress protection	IP66
Data sheet	PM 07.07



732.51, 733.51, 732.31, 733.31

For the process industry, all-metal media chamber

Nominal size	100, 160 mm
Scale range	0 ... 16 mbar to 0 ... 40 bar
Ambient temperature	To -70 °C
Accuracy class	1.6
Ingress protection	IP54, with liquid filling IP65
Data sheet	PM 07.05



732.14, 733.14, 762.14, 763.14

For the process industry, high overload safety to 650 bar

Nominal size	100, 160 mm
Scale range	<ul style="list-style-type: none"> ■ 0 ... 60 to 0 ... 250 mbar (measuring cell DN 140) ■ 0 ... 0.25 to 0 ... 40 bar (measuring cell DN 82)
Accuracy class	1.6
Ingress protection	IP54, with liquid filling IP65
Data sheet	PM 07.13



Absolute pressure gauges

Absolute pressure gauges are used when measured pressures are independent of the natural fluctuations in atmospheric pressure. The pressure of the media is determined against a reference pressure, which corresponds to the absolute pressure zero point. For this, the reference chamber is completely evacuated, so that there is a near-perfect vacuum in it.

Applications for these high-precision measuring instruments are, for example, monitoring of vacuum pumps and vacuum packaging machines. They are also used in laboratories, in order to monitor condensation pressures or to determine the vapour pressure of liquids.



**532.52, 533.52,
532.53, 533.53,
532.54, 533.54**

High overload safety



Nominal size	100, 160 mm
Scale range	0 ... 25 mbar to 0 ... 25 bar abs., high overload safety
Accuracy class	1.0 or 1.6 or 2.5
Ingress protection	IP54, with liquid filling IP65
Data sheet	PM 05.02

Digital pressure gauges



CPG1200
Digital pressure gauge

Measuring range	-1 ... 1,000 bar
Accuracy	Down to 0.25 % FS
Special feature	<ul style="list-style-type: none"> ■ Integrated data logger ■ WIKA-Cal compatible ■ Data transmission via USB or Bluetooth® ■ Robust case, IP65
Data sheet	CT 10.20



CPG1500
Precision digital pressure gauge

Measuring range	0 ... 10,000 bar
Accuracy	Down to 0.025 % FS
Special feature	<ul style="list-style-type: none"> ■ Integrated data logger ■ WIKA-Cal compatible ■ Data transmission via Bluetooth® ■ Password protection possible ■ Robust case, IP65
Data sheet	CT 10.51

Pressure sensor assemblies and modules

Customer-specific electronic pressure measurement solutions

We see ourselves not only as a provider of top quality measurement technology, but also as a highly competent partner that is able to create individually designed solutions together with you. In close cooperation with you, we are ready to develop products that are tailor-made to cater for your individual needs. Create your perfect pressure sensor solution together with us. Here, the experience from a multitude of completed projects is incorporated – thus we can refer back to numerous proven solutions and components. As required, we will adapt our systems to your individual application or develop new ones.

Talk to us – we are happy to provide you with advice!



MPR-1
Pressure sensor module

Non-linearity (± % of span)	≤ 0.125 or 0.25
Measuring range	<ul style="list-style-type: none"> ■ 0 ... 0.4 to 0 ... 25 bar ■ 0 ... 0.4 to 0 ... 25 bar abs.
Special feature	<ul style="list-style-type: none"> ■ 19 mm spanner width for limited mounting space ■ No calibration necessary, due to compensated output signal
Signal	Analogue and digital
Data sheet	PE 81.64



MTF-1
Pressure sensor module

Non-linearity (± % of span)	≤ 0.125 or 0.25
Measuring range	<ul style="list-style-type: none"> ■ 0 ... 10 to 0 ... 1,000 bar ■ -1 ... +9 to -1 ... +24 bar
Special feature	<ul style="list-style-type: none"> ■ Compact design ■ Low energy consumption ■ Additional temperature indication ■ Dry, welded measuring cell
Signal	Analogue and digital
Data sheet	PE 83.01

Process transmitters

Process transmitters are suitable for many industrial measuring requirements in the widest variety of applications. They monitor pumps, detect the level in containers or calculate quantities for flow measurement in pipelines.

Process transmitters differentiate themselves from pressure sensors through their increased range of functionality:

They feature integrated displays, offer high measurement accuracies and freely scalable measuring ranges, communicate via digital bus signals and can be delivered with a multitude of case variants. Through connection to diaphragm seals, WIKA process transmitters are also suitable for the harshest operating conditions.



UPT-20
Universal process transmitter with standard connection, Ex intrinsically safe

Non-linearity (% of span)	≤ 0.1
Output signal	4 ... 20 mA, HART®
Measuring range	<ul style="list-style-type: none"> ■ 0 ... 0.4 to 0 ... 5,000 bar ■ 0 ... 1.6 to 0 ... 40 bar abs. ■ -0.2 ... +0.2 to -1 ... +40 bar
Special feature	<ul style="list-style-type: none"> ■ Multi-functional display ■ Freely scalable measuring range ■ Simple menu navigation ■ Conductive plastic case or stainless steel case ■ Large LC display, rotatable
Data sheet	PE 86.05



UPT-21
Universal process transmitter with flush process connection, Ex intrinsically safe

Non-linearity (% of span)	≤ 0.1
Output signal	4 ... 20 mA, HART®
Measuring range	<ul style="list-style-type: none"> ■ 0 ... 0.4 to 0 ... 600 bar ■ 0 ... 1.6 to 0 ... 40 bar abs. ■ -0.2 ... +0.2 to -1 ... +40 bar
Special feature	<ul style="list-style-type: none"> ■ Hygienic process connections in different designs ■ Electropolished stainless steel case for hygienic applications ■ Freely scalable measuring range ■ Conductive plastic case or stainless steel case ■ Large LC display, rotatable
Data sheet	PE 86.05



DPT-EL
Electronic differential pressure transmitter in primary and secondary circuits

Non-linearity (% of span)	≤ 0.05 ... 0.1
Output signal	4 ... 20 mA, HART® protocol (optional), PROFIBUS® PA, FOUNDATION™ Fieldbus
Measuring range	<ul style="list-style-type: none"> ■ 0 ... 0.1 to 0 ... 1,000 bar ■ 0 ... 1.6 to 0 ... 40 bar abs. ■ -0.05 ... +0.05 to -1 ... +40 bar
Special feature	<ul style="list-style-type: none"> ■ Simple, uncomplicated installation ■ Mounting possible without diaphragm seal ■ Elimination of capillaries, that can easily kink ■ For applications to SIL 2 (SIL 3) ■ Can be combined with two different designs of transmitters from model IPT-2x and/or model CPT-2x
Data sheet	PE 86.23



IPT-20, IPT-21

Process pressure transmitter with welded metal measuring cell

Non-linearity (% of span)	≤ 0.075 ... 0.1
Output signal	4 ... 20 mA, HART® protocol (optional), PROFIBUS® PA, FOUNDATION™ Fieldbus
Measuring range	<ul style="list-style-type: none"> ■ 0 ... 0.1 to 0 ... 4,000 bar ■ 0 ... 0.1 to 0 ... 40 bar abs. ■ -1 ... 0 to -1 ... +40 bar
Special feature	<ul style="list-style-type: none"> ■ Freely scalable measuring ranges ■ Case from plastic, aluminium or stainless steel ■ Flush process connection (optional) ■ With integrated display and instrument mounting bracket for wall/pipe mounting (optional) ■ Process temperature ranges to 200 °C
Data sheet	PE 86.06

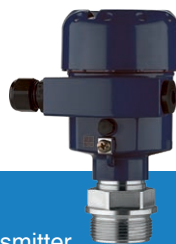

CPT-20, CPT-21

Process pressure transmitter with capacitive ceramic measuring cell

Non-linearity (% of span)	≤ 0.05
Output signal	4 ... 20 mA, HART® protocol (optional), PROFIBUS® PA, FOUNDATION™ Fieldbus
Measuring range	<ul style="list-style-type: none"> ■ 0 ... 0.025 to 0 ... 100 bar abs. ■ -1 ... 0 to -1 ... +100 bar
Special feature	<ul style="list-style-type: none"> ■ Particularly robust, ceramic measuring cell ■ Dry ceramic measuring cell with variable sealing concept ■ Freely scalable measuring ranges ■ Case from plastic, aluminium or stainless steel ■ Flush process connection (optional)
Data sheet	PE 86.07



DPT-20

Differential pressure transmitter, intrinsically safe or with flameproof enclosure

Non-linearity (% of span)	≤ 0.065 ... 0.1
Output signal	4 ... 20 mA, HART® protocol (optional), PROFIBUS® PA, FOUNDATION™ Fieldbus
Measuring range	0 ... 10 mbar to 0 ... 16 bar
Special feature	<ul style="list-style-type: none"> ■ Freely scalable measuring ranges ■ Static load 160 bar, optionally 400 bar ■ Case from plastic, aluminium or stainless steel ■ With integrated display and instrument mounting bracket for wall/pipe mounting (optional) ■ 3- or 5-way valve optional ■ SIL 2 per IEC 61508
Data sheet	PE 86.22

Pressure measuring instruments with self-monitoring pressure indication



DMS-FP

Diaphragm monitoring system with clamp connection

Non-linearity (% of span)	≤ 0.1 %
Output signal	<ul style="list-style-type: none"> ■ 4 ... 20 mA ■ 4 ... 20 mA with a superimposed HART® communication signal (option: SIL qualification) <p>HART® specification: 7.3 FOUNDATION™ Fieldbus PROFIBUS® PA</p>
Measuring range	< 40 bar
Special feature	<ul style="list-style-type: none"> ■ Double-diaphragm system to ensure the separation of the process and the pressure measuring instrument ■ Clamp connection easy to open for cleaning and seal replacement ■ Suitable for SIP and CIP
Data sheet	DS 95.20



DMSU21SA

Diaphragm monitoring system with HART® protocol

Non-linearity (% of span)	<ul style="list-style-type: none"> ■ 0.1 % ■ 0.5 %
Output signal	<ul style="list-style-type: none"> ■ 4 ... 20 mA with HART® signal (HART® rev. 7) ■ 4 ... 20 mA
Measuring range	<ul style="list-style-type: none"> ■ -1 ... +1.5 to -1 ... +24 bar ■ -14.5 ... 20 to -14.5 ... +350 psi
Special feature	<ul style="list-style-type: none"> ■ Double-diaphragm system prevents contamination of process and environment ■ Hygienic process connections in different designs ■ Signal transmission and configuration with only one cable per measuring location ■ Minimum installation costs, even with retrofitting
Data sheet	DS 95.11



DMSU22SA

In-line process transmitter

Non-linearity (% of span)	1 % (at process temperature)
Output signal	<ul style="list-style-type: none"> ■ 4 ... 20 mA with HART® signal (HART® rev. 7) ■ 4 ... 20 mA
Measuring range	<ul style="list-style-type: none"> ■ 1 ... +15 bar ■ 0 ... 16 bar abs. ■ 14.5 ... +200 psi
Special feature	<ul style="list-style-type: none"> ■ Dead-space free hygienic design with thick-walled sensor tube from stainless steel ■ In-line pressure measurement with sensor tube without system fill fluid ■ Continuous sensor monitoring of the double-tube system prevents contamination of process and environment ■ Suitable for SIP and CIP ■ EHEDG-certified and 3-A marked
Data sheet	DS 95.03

Pressure sensors for viscous and solids-containing media



A-10

For general industrial applications

Non-linearity (± % of span) ≤ 0.25 or 0.5 BFSL

Measuring range

- 0 ... 0.05 to 0 ... 1,000 bar
- 0 ... 0.1 to 0 ... 25 bar abs.
- -0.05 ... 0 to -1 ... +24 bar

Special feature

- Excellent quality
- Exceptionally large variety
- Availability at short notice
- Particularly cost-efficient

Data sheet PE 81.60



S-20

For demanding industrial applications

Non-linearity (± % of span) ≤ 0.125, 0.25 or 0.5 BFSL

Measuring range

- 0 ... 0.4 to 0 ... 1,600 bar
- 0 ... 0.4 to 0 ... 40 bar abs.
- -0.4 ... 0 to -1 ... +59 bar

Special feature

- Extreme variety
- High accuracy
- Proven technology
- Special versions available

Data sheet PE 81.61



S-11

For viscous and solids-containing media

Non-linearity (± % of span) ≤ 0.2 BFSL

Measuring range

- 0 ... 0.1 to 0 ... 600 bar
- 0 ... 0.25 to 0 ... 16 bar abs.
- -0.1 ... 0 to -1 ... +24 bar

Special feature

- Flush process connection
- Medium temperature to 150 °C
- Comprehensive stocks

Data sheet PE 81.02



IS-3

Intrinsic safety Ex ia

Non-linearity (± % of span) ≤ 0.2 BFSL

Measuring range

- 0 ... 0.1 to 0 ... 6,000 bar
- 0 ... 0.25 to 0 ... 25 bar abs.
- -1 ... 0 to -1 ... +24 bar

Special feature

- Ignition protection type Ex ia
- Large selection of approvals
- Exceptionally large variety
- Excellent quality, proven in the field

Data sheet PE 81.58



E-10, E-11

Flameproof enclosure Ex db

Non-linearity (± % of span) ≤ 0.2 BFSL

Measuring range

- 0 ... 0.4 to 0 ... 1,000 bar
- 0 ... 0.4 to 0 ... 16 bar abs.
- -1 ... 0 to -1 ... +25 bar

Special feature

- Low-power version
- For sour gas applications (NACE)
- Flush process connection (optional)
- Further worldwide Ex approvals

Data sheet PE 81.27



A-1200

With IO-Link, PNP or NPN switching output

Accuracy (± % of span) ≤ 0.5 or ≤ 1

Measuring range

- 0 ... 0.4 to 0 ... 1,000 bar
- 0 ... 0.4 to 0 ... 25 bar abs.
- 1 ... 0 to -1 ... +24 bar

Special feature

- IO-Link version 1.1
- Medium temperature to +125 °C
- Multicolour 360° LED status display

Data sheet PE 81.90

EAC

HP-2

For highest-pressure applications to 15,000 bar



Accuracy (± % of span) ≤ 0.25 or 0.5

Measuring range 0 ... 1,600 to 0 ... 15,000 bar

Special feature

- Very high long-term stability
- Excellent load cycle stability
- Cavitation protection (optional)

Data sheet PE 81.53



M-10, M-11

Spanner width 19 mm



Non-linearity (± % of span) ≤ 0.2 BFSL

Measuring range 0 ... 10 to 0 ... 1,000 bar

Special feature

- Small spanner width 19 mm
- Flush connection G 1/4 available

Data sheet PE 81.25

EAC

P-30, P-31

For precision measurements



Non-linearity (± % of span) ≤ 0.04 BFSL

Measuring range

- 0 ... 0.25 to 0 ... 1,000 bar
- 0 ... 0.25 to 0 ... 25 bar abs.
- -1 ... 0 to -1 ... +15 bar

Special feature

- No additional temperature error in the range 10 ... 60 °C
- Flush process connection (optional)
- Analogue, CANopen® or USB

Data sheet PE 81.54

OEM pressure sensors



O-10

For industrial applications

Non-linearity
(± % of span) ≤ 0.5 BFSL

Measuring range
■ 0 ... 6 to 0 ... 600 bar
■ -1 ... +5 to -1 ... +59 bar

Special feature
■ Customer-specific solutions
■ Excellent long-term stability
■ Consistent quality
■ Good delivery performance

Data sheet PE 81.65



MH-4

For mobile working machines

Non-linearity
(per IEC 62828-1) ≤ ±0.25 % of span (BFSL)

Measuring range 0 ... 6 to 0 ... 1,000 bar

Special feature
■ For extreme operating conditions
■ Reliable and accurate
■ Customer-specific solutions
■ High production capacities

Data sheet PE 81.63



MH-4-CAN

For mobile working machines,
CANopen®/J1939

Non-linearity
(per IEC 62828-1) ≤ ±0.25 % of span (BFSL)

Measuring range 0 ... 40 to 0 ... 600 bar

Special feature
■ For extreme operating conditions
■ Signal stability thanks to CANopen®
■ Reliable and accurate
■ Customer-specific solutions
■ High production capacities

Data sheet PE 83.02



MH-3-HY

For mobile hydrogen
applications

Accuracy
(± % of span) ≤ 1

Measuring range 0 ... 20 to 0 ... 600 bar

Special feature
■ Approval per EC79/2009
■ Compact and robust design
■ Diagnostic function (optional)

Data sheet PE 81.59

MG-1

For medical gases

Non-linearity
(± % of span) ≤ 0.5 BFSL

Measuring range 0 ... 6 to 0 ... 400 bar

Special feature Cleaned, packed and marked for oxygen
per international standards

Data sheet PE 81.44



R-1

For heating and refrigeration

Accuracy
(± % of span) ≤ 2

Measuring range
■ 0 ... 6 to 0 ... 160 bar
■ -1 ... +7 to -1 ... +45 bar

Special feature
■ Special case design for the best possible condensation tightness
■ Resistant to all common refrigerants
■ Wetted parts from stainless steel

Data sheet PE 81.45

Pressure gauges with output signal

The multi-functional intelliGAUGEs present a cost-effective and, at the same time, reliable solution for nearly all pressure measurement applications. They combine the analogue indication of a mechanical pressure gauge, needing no auxiliary power, with the electrical output signal of a pressure sensor. These hybrid instruments are available with all commonly used electrical signals. The sensor works in a non-contact way, without any influence on the measuring signal. Many instruments are available in versions for use in hazardous areas.

Depending on the pressure gauge, the following electrical output signals are possible:

- 0.5 ... 4.5 V ratiometric
- 4 ... 20 mA, 2-wire
- 4 ... 20 mA, 2-wire with Ex approvals
- 0 ... 20 mA, 3-wire
- 0 ... 10 V, 3-wire

For pressure gauges with nominal sizes 100 and 160 mm, the electrical output signals can also be combined with switch contacts.



PGT21

Bourdon tube,
stainless steel case

Nominal size	50, 63 mm
Scale range	0 ... 1.6 to 0 ... 400 bar
Accuracy class	2.5
Ingress protection	IP65 (IP67 optional)
Data sheet	PV 11.03



PGT23.063

Bourdon tube, for the process
industry, safety version

Nominal size	63 mm
Scale range	0 ... 1 to 0 ... 1,000 bar
Accuracy class	1.6
Ingress protection	IP54, filled IP65
Data sheet	PV 12.03



PGT23.100, PGT23.160

Bourdon tube, for the process industry,
standard or safety version

Nominal size	100, 160 mm
Scale range	0 ... 0.6 to 0 ... 1,600 bar
Accuracy class	1.0
Ingress protection	IP54, filled IP65
Data sheet	PV 12.04



PGT43

Diaphragm element,
for the process industry, high
overload safety up to 10 times the
full scale value, max. 40 bar

Nominal size	100, 160 mm
Scale range	0 ... 16 mbar to 0 ... 25 bar
Accuracy class	1.6
Ingress protection	IP54, with liquid filling IP65
Data sheet	PV 14.03



PGT43HP

Diaphragm element,
for the process industry,
high overload safety to 40, 100 or
400 bar

Nominal size	100, 160 mm
Scale range	0 ... 16 mbar to 0 ... 40 bar
Accuracy class	1.6
Ingress protection	IP54, with liquid filling IP65
Data sheet	PV 14.07



PGT63HP

Capsule element,
for the process industry,
high overload safety

Nominal size	100, 160 mm
Scale range	2.5 ... 100 mbar
Accuracy class	1.6
Ingress protection	IP54
Data sheet	PV 16.06

Pressure gauges with output signal

intelliGAUGE®



DPGT43

Differential pressure,
for the process industry,
all-metal media chamber

Nominal size	100, 160 mm
Scale range	0 ... 16 mbar to 0 ... 40 bar
Accuracy class	1.6
Ingress protection	IP54, filled IP65
Data sheet	PV 17.05



DPGT43HP

Differential pressure,
for the process industry,
high overload safety to 650 bar

Nominal size	100, 160 mm
Scale range	0 ... 60 mbar to 0 ... 40 bar
Accuracy class	1.6
Ingress protection	IP54, filled IP65
Data sheet	PV 17.13



DPGT40

Differential pressure,
with integrated working pressure
indication (DELTA-trans)

Nominal size	100 mm
Scale range	0 ... 160 mbar to 0 ... 10 bar
Accuracy class	2.5 (1.6 optional)
Ingress protection	IP65
Data sheet	PV 17.19



APGT43

Absolute pressure,
for the process industry

Nominal size	100, 160 mm
Scale range	0 ... 25 mbar to 0 ... 25 bar abs.
Accuracy class	2.5
Ingress protection	IP54, with liquid filling IP65
Data sheet	PV 15.02

Contact pressure gauges

Control systems are gaining more and more importance in industrial applications. Consequently, mere pressure indication on the measuring instrument itself is no longer sufficient, rather the measured value must be transferred to the control system via an electrical signal, e.g. by closing or opening of a circuit. WIKA is focusing on its contact pressure gauges in order to satisfy this trend.

All instruments with inductive contacts are certified in accordance with ATEX Ex ia.

Depending on the model the following contacts are built in:

- Magnetic snap-action contact, e.g. model 821, for general applications
- Inductive contact model 831, for hazardous areas
- Electronic contact model 830 E, for PLC
- Reed contact model 851, for general applications and PLC
- Microswitch model 850
- Transistor output NPN or PNP

VdS



PGS21

Bourdon tube,
stainless steel case

Nominal size	40, 50, 63 mm
Scale range	0 ... 2.5 to 0 ... 400 bar
Accuracy class	2.5
Ingress protection	IP65
Special feature	Version with VdS or LPCB approval possible
Data sheet	PV 21.02

PGS25

Bourdon tube, with
electronic pressure switch,
stainless steel case

Nominal size	50, 63 mm
Scale range	0 ... 1.6 to 0 ... 400 bar
Accuracy class	2.5
Ingress protection	IP65
Data sheet	PV 21.04



PGS21.100, PGS21.160

Bourdon tube, stainless steel case

Nominal size	100, 160 mm
Scale range	0 ... 0.6 to 0 ... 600 bar
Accuracy class	1.0
Ingress protection	IP54
Data sheet	PV 22.01



PGS23.100, PGS23.160

Bourdon tube, for the process industry,
standard or safety version

Nominal size	100, 160 mm
Scale range	0 ... 0.6 to 0 ... 1,600 bar
Accuracy class	1.0
Ingress protection	IP65 or IP66
Data sheet	PV 22.02



PGS23.063

Bourdon tube, for the process
industry, safety version

Nominal size	63 mm
Scale range	0 ... 4 to 0 ... 400 bar
Accuracy class	1.6
Ingress protection	IP54
Data sheet	PV 22.03



PGS43.100, PGS43.160

Diaphragm element, for the process industry,
high overload safety up to 10 times the
full scale value, max. 40 bar

Nominal size	100, 160 mm
Scale range	0 ... 25 mbar to 0 ... 25 bar
Accuracy class	1.6
Ingress protection	IP54, with liquid filling IP65
Data sheet	PV 24.03

Contact pressure gauges



432.36, 432.56 with 8xx

Diaphragm element, for the process industry, high overload safety to 100 or 400 bar

Nominal size	100, 160 mm
Scale range	0 ... 25 mbar to 0 ... 40 bar
Accuracy class	1.6
Ingress protection	IP54, with liquid filling IP65
Data sheet	PV 24.07



532.53 with 8xx

Absolute pressure, for the process industry, high overload safety

Nominal size	100, 160 mm
Scale range	0 ... 25 mbar to 0 ... 25 bar abs.
Accuracy class	1.6
Ingress protection	IP54, with liquid filling IP65
Data sheet	PV 25.02



632.51 with 8xx

Capsule element, for the process industry, high overload safety

Nominal size	100, 160 mm
Scale range	0 ... 2.5 to 0 ... 100 mbar
Accuracy class	1.6
Ingress protection	IP54
Data sheet	PV 26.06



DPGS40

Differential pressure, with microswitches, with integrated working pressure indication (DELTA-comb)

Nominal size	100 mm
Scale range	0 ... 250 mbar to 0 ... 10 bar
Accuracy class	2.5 (1.6 optional)
Ingress protection	IP65
Data sheet	PV 27.20



DPGS40TA

Differential pressure, with microswitches, with integrated working pressure indication (DELTA-comb), with component testing

Nominal size	100 mm
Scale range	0 ... 250 mbar to 0 ... 10 bar
Accuracy class	2.5 (1.6 optional)
Ingress protection	IP65
Data sheet	PV 27.22



DPGS43

Differential pressure, for the process industry, all-metal media chamber

Nominal size	100, 160 mm
Scale range	0 ... 16 mbar to 0 ... 40 bar
Accuracy class	1.6
Ingress protection	IP54, filled IP65
Data sheet	PV 27.05



DPGS43HP

Differential pressure, for the process industry, high overload safety to 400 bar

Nominal size	100, 160 mm
Scale range	0 ... 60 mbar to 0 ... 40 bar
Accuracy class	1.6
Ingress protection	IP54, filled IP65
Data sheet	PV 27.13

Pressure switches

Electronic pressure switches

UL LISTED ENEC ATEX IO-Link



PSD-4

Electronic pressure switch with display

Accuracy
(± % of span) ≤ 0.5

Measuring range

- 0 ... 0.4 to 0 ... 1,000 bar
- 0 ... 0.4 to 0 ... 25 bar abs.
- -1 ... 0 to -1 ... +24 bar

Special feature

- Condition monitoring via IO-Link
- Reduction of variants
- Easy installation, good readability
- Parameterisation via 3 buttons

Data sheet PE 81.86

UL LISTED IO-Link



PSD-4-ECO

Electronic pressure switch with display

Accuracy
(± % of span) ≤ 1.0

Measuring range

- 0 ... 0.4 to 0 ... 1,000 bar
- 0 ... 0.4 to 0 ... 25 bar abs.
- -1 ... 0 to -1 ... +24 bar

Special feature

- Good/Bad indication through parameterisable digital display (red/green)
- Compact size enables easy installation in confined spaces
- Optimised design makes OEM machine integration easier
- Designed for rough demands to 50g shock and -40 ... +125 °C [-40 ... +257 °F]

Data sheet PE 81.69

UL LISTED ENEC IO-Link



A-1200

With IO-Link, PNP or NPN switching output

Accuracy
(± % of span) ≤ 0.5 or ≤ 1

Measuring range

- 0 ... 0.4 to 0 ... 1,000 bar
- 0 ... 0.4 to 0 ... 25 bar abs.
- 1 ... 0 to -1 ... +24 bar

Special feature

- IO-Link version 1.1
- Medium temperature to +125 °C
- Multicolour 360° LED status display

Data sheet PE 81.90

Pressure switches

Mechanical pressure switches for industrial applications



PSM01
Compact pressure switch

Setting range	<ul style="list-style-type: none"> ■ -0.85 ... -0.15 bar ■ 0.2 ... 2 bar to 30 ... 320 bar
Switching function	Normally open, normally closed, change-over contact
Material	Galvanised steel or stainless steel
Switching power	<ul style="list-style-type: none"> ■ 2 A, AC 48 V ■ 1 A / 2 A, DC 24 V
Data sheet	PV 34.81



PSM02
Compact pressure switch, settable hysteresis

Setting range	<ul style="list-style-type: none"> ■ -0.85 ... -0.15 bar ■ 0.2 ... 2 bar to 30 ... 320 bar
Switching function	Normally open, normally closed, change-over contact
Material	Galvanised steel or stainless steel
Switching power	<ul style="list-style-type: none"> ■ 2 A / 4 A, AC 250 V ■ 2 A / 4 A, DC 24 V
Data sheet	PV 34.82



PSM-520
Pressure switch, settable hysteresis

Setting range	<ul style="list-style-type: none"> ■ -0.4 ... +7 bar ■ 0 ... 5 bar to 6 ... 30 bar
Switching function	Normally open, normally closed, change-over contact
Material	<ul style="list-style-type: none"> ■ Bellows: Copper alloy CuSn6 per EN 1652 ■ Process connection: free cutting steel EN1A per EN 10277-3, tin-plated
Switching power	10 A / 6 A, AC 230 V
Data sheet	PV 35.01



PSM-550
Pressure switch, for demanding industrial applications

Setting range	<ul style="list-style-type: none"> ■ -1 ... 0 and -0.8 ... +5 bar ■ 0 ... 300 mbar ■ 0.1 ... 1.1 bar to 10 ... 30 bar
Switching function	Change-over contact (SPDT)
Material	<ul style="list-style-type: none"> ■ Bellows / Process connection: Copper alloy CuSn6 per EN 1652 or stainless steel 1.4401 ■ With NBR diaphragm: Process connection: free cutting steel EN1A per EN 10277-3, tin-plated
Switching power	4 A / 10 A, AC 230 V
Data sheet	PV 35.03



PSM-700
Pressure switch, high adjustability of switch differential

Setting range	<ul style="list-style-type: none"> ■ -1 ... 1.5 bar ■ 0.2 ... 1.6 bar, 7 ... 35 bar
Switching function	Change-over contact (SPDT and DPDT)
Material	<ul style="list-style-type: none"> ■ Measuring element: Stainless steel 316L ■ Process connection: Stainless steel 316L ■ Case: Aluminium
Switching power	Up to AC 250 V/15 A
Data sheet	PV 35.05

Mechanical pressure switches for the process industry

Due to the use of high-quality microswitches, the mechanical pressure switches are notable for their high precision and long-term stability. Furthermore, direct switching of electrical loads up to AC 250 V/20 A is enabled, while simultaneously ensuring high switch point reproducibility.

The instruments come with a SIL certificate and are thus particularly suited for safety-critical applications. In addition, with their 'intrinsically safe' and 'flameproof enclosure' ignition protection types the pressure switches are ideally suited for permanent use in hazardous areas.

All mechanical pressure switches for the process industry are available with EAC certificate and technical passport.



PXS, PXA

Miniature pressure switch

Setting range 1 ... 2.5 to 200 ... 1,000 bar

Ignition protection type Ex ia or Ex d

Switch 1 x SPDT or DPDT

Switching power ■ AC 250 V/5 A
■ DC 24 V/5 A

Data sheet PV 34.36, PV 34.38



PCS, PCA

Compact pressure switch

Setting range -1 ... -0.2 to 200 ... 1,000 bar

Ignition protection type Ex ia or Ex d

Switch 1 x SPDT or DPDT

Switching power ■ AC 250 V/15 A
■ DC 24 V/2 A

Data sheet PV 33.30, PV 33.31



MW, MA

Diaphragm pressure switch

Setting range 0 ... 16 mbar to 30 ... 600 bar

Ignition protection type Ex ia or Ex d

Switch 1 or 2 x SPDT or 1 x DPDT

Switching power ■ AC 250 V/20 A
■ DC 24 V/2 A

Data sheet PV 31.10, PV 31.11



BWX, BA

Bourdon tube pressure switch

Setting range 0 ... 2.5 to 0 ... 1,000 bar

Ignition protection type Ex ia or Ex d

Switch 1 or 2 x SPDT or 1 x DPDT

Switching power ■ AC 250 V/20 A
■ DC 24 V/2 A

Data sheet PV 32.20, PV 32.22



DW, DA

Differential pressure switch

Setting range 0 ... 16 mbar to 0 ... 40 bar,
static pressure to 160 bar

Ignition protection type Ex ia or Ex d

Switch 1 or 2 x SPDT or 1 x DPDT

Switching power ■ AC 250 V/20 A
■ DC 24 V/2 A

Data sheet PV 35.42, PV 35.43, PV 35.50



APW, APA

Absolute pressure switch

Setting range 0 ... 25 mbar to 0 ... 1.5 bar abs.

Proof pressure 11 bar abs.

Ignition protection type Ex ia or Ex d

Switch 1 or 2 x SPDT or 1 x DPDT

Data sheet PV 35.49, PV 35.48

Diaphragm seal systems

These combinations of diaphragm seals and pressure gauges or pressure sensors feature fast availability. They are particularly suitable for demanding measuring requirements in the pharmaceutical and biotechnology industries, food and beverage industries, and through to the oil and gas, chemical, petrochemical and semiconductor industries.

The diaphragm seal systems can be used for processes with gases, compressed air or vapour, with liquid, pasty, powdery and

crystallising media and also with aggressive, adhesive, corrosive, highly viscous, environmentally hazardous or toxic media.

The diaphragm seal is directly welded to the pressure gauge or pressure sensor. The diaphragm made of stainless steel provides for the separation from the medium. The pressure is transmitted to the measuring instrument via the system fill fluid which is inside the diaphragm seal system.

With flange connection



DSS26M

With pressure gauge per EN 837-1, internal diaphragm

Applications with small flange process connections in the process industry

PN max.	40 bar
System fill fluid	KN2 for general applications
Data sheet	DS 95.09

With threaded connection



DSS34M

With pressure gauge per EN 837-1, welded design

Applications with high requirements in the chemical, petrochemical and water treatment industries

PN max.	60 bar
System fill fluid	KN2 for general applications
Data sheet	DS 95.15



Extensive information can be found in our brochure “Diaphragm seals – combinations and accessories” at www.wika.com.

DSS26T

With high-quality pressure sensor, internal diaphragm

Applications with small flange process connections in the process industry

PN max.	40 bar
System fill fluid	KN2 for general applications
Data sheet	DS 95.10

DSS34T

With high-quality pressure sensor, welded design

Applications with high requirements in the chemical, petrochemical and water treatment industries

PN max.	60 bar
System fill fluid	KN2 for general applications
Data sheet	DS 95.16



Extensive information can be found in our brochure “Diaphragm seal systems with short delivery times” at www.wika.com.

Valves and mounting accessories

Valves and protective devices for increased safety and service life. Via cocks, shut-off valves, valve manifolds or monoflanges, pressure measuring instruments can be securely separated from the process during commissioning, maintenance or calibration. Protective devices, such as syphons, overpressure protectors

and snubbers, increase the service life and expand the range of applications for pressure measuring instruments. In addition to the extensive selection of instrumentation valves and accessories, WIKA also offers the qualified assembly of various individual parts to form a complete measuring assembly ("instrument hook-up").



IV1
Needle valve and multiport needle valve

Application	For shutting off pressure measuring instruments with threaded connection
Version	Needle valve and multiport needle valve
Material	Stainless steel
Nominal pressure	To PN 420 (6,000 psi) Option: to PN 680 (10,000 psi)
Data sheet	AC 09.22

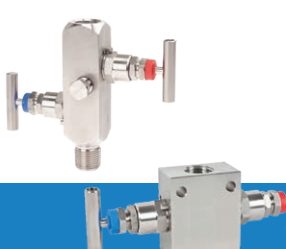

IV2
Block-and-bleed valve, square or flat form

Application	For shutting off and venting pressure measuring instruments with threaded connection
Version	Block-and-bleed valve
Material	Stainless steel
Nominal pressure	To PN 420 (6,000 psi) Option: to PN 680 (10,000 psi)
Data sheet	AC 09.19

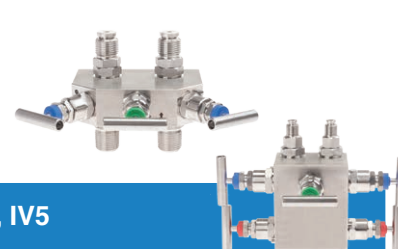

IV3, IV5
Valve manifold for differential pressure measuring instruments

Application	For shutting off, pressure equalising as well as purging and venting differential pressure measuring instruments
Version	3-way and 5-way valve
Material	Stainless steel
Nominal pressure	To PN 420 (6,000 psi) Option: to PN 680 (10,000 psi)
Data sheet	AC 09.23



IVM
Monoflanges

Application	For shutting off and venting pressure measuring instruments with flange connection
Version	Flange connection per ASME or EN
Material	Stainless steel
Nominal pressure	To PN 420 (6,000 psi)
Data sheet	AC 09.17



IBM, IBF
Monoblock as double block-and-bleed valve

Application	Direct connection of pressure measuring instruments to pipelines or containers without interface valves. Control panels, lubrication systems, dry gas seals
Version	Flange/threaded, flange/flange or threaded/threaded
Material	Stainless steel
Nominal pressure	BF: class 150 ... class 2,500, in line with ASME B16.5 PN 16 ... PN 100, in line with EN 1092-1 IBM: 6,000 ... 10,000 psi (420 ... 690 bar)
Data sheet	AC 09.24, AC 09.25



910.10, 910.11
Stopcock and DIN shut-off valve

Application	For shutting off pressure measuring instruments with threaded connection
Version	910.10: per DIN 16261, DIN 16262, DIN 16263 910.11: per DIN 16270, DIN 16271, DIN 16272
Material	Brass, steel, stainless steel
Nominal pressure	910.10: to 25 bar 910.11: to 400 bar
Data sheet	AC 09.01, AC 09.02

Valves and mounting accessories

ERC

BV Ball valve



Application First shut-off valve for pressure tap to local instrument installation, media distribution, drain or vent in pipelines

Version	Process and instrument version
Material	Stainless steel 316L
Nominal pressure	To PN 420 (6,000 psi) Option: to PN 680 (10,000 psi)
Data sheet	AC 09.28

HPNV High-pressure needle valve



Application For injection systems, test benches, hydraulic power packs, blow-out protection, blasting/cutting with water, high-pressure cleaning

Version	2-way valve, straight or angled bore; 3-way valve, one or two pressure connections
Material	Stainless steel
Nominal pressure	15,000 ... 60,000 psi [1,034 ... 4,136 bar] Option: To PN 680 (10,000 psi)
Data sheet	AC 09.27

910.12 Snubber



Application For the protection of pressure measuring instruments from pressure surges and pulsations

Material	Brass, steel, stainless steel
Nominal pressure	To 400 bar
Data sheet	AC 09.03

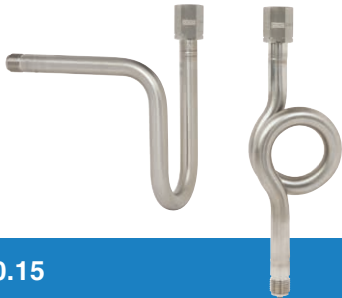

910.15 Syphons and connecting pipes

Application For the protection of pressure measuring instruments from excessive pulsation and heat

Version	U-form, trumpet form, compact form, standard
Material	Steel, stainless steel
Nominal pressure	To 160 bar
Data sheet	AC 09.06

HPFA High-pressure fittings and accessories

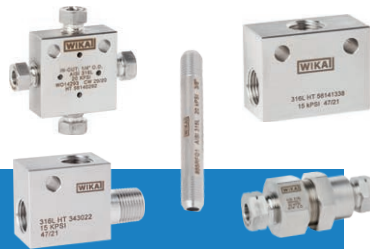

Application For high-pressure applications in control panels, where the space is restricted, or test benches

Version	Elbow fitting, T-fitting, cross fitting, bulk-head connector, anti-vibration gland, gland collar, threaded connection, nipple, sealing cap, blind plug
Material	Stainless steel
Nominal pressure	15,000 ... 60,000 psi [1,034 ... 4,136 bar]
Data sheet	AC 09.32

Extensive information can be found in our brochure "Instrumentation valves and mounting accessories" at www.wika.com.



Electrical accessories



A-AI-1, A-IAI-1



LCD attachable indicator, 50 x 50 mm

Input	4 ... 20 mA, 2-wire
Auxiliary power	Supply from the 4 ... 20 mA current loop
Special feature	Model A-IAI-1 intrinsically safe per ATEX
Data sheet	AC 80.07



M12 x 1 cable

Preassembled
cables M12 x 1



Circular connector M12 x 1, 4- and 5-pin
Straight and angled version
2, 5 or 10 m cable
Ingress protection IP67

904

Control unit
for inductive contacts model 831



Application	For operating measuring instruments with inductive switch contacts
Data sheet	AC 08.04

Dial thermometers

Our dial thermometers work on the bimetal, expansion or gas actuation principle. This enables scale ranges of -200 ... +700 °C in different class accuracies, response times and resilience to environmental influences. Diverse connection designs, stem diameters and individual stem lengths enable a flexible measuring point design.

Dial thermometers with capillaries are particularly versatile. All thermometers are suited for operation in a thermowell if necessary.

Bimetal thermometers



A43
Heating technology

Nominal size	63, 80, 100 mm
Scale range	-30 ... +120 °C
Permissible operating pressure at thermowell/stem	Max. 6 bar
Wetted parts	Copper alloy
Data sheet	TM 43.01



A48
Refrigeration and air-conditioning applications

Nominal size	63, 80, 100, 160 mm
Scale range	-30 ... +120 °C
Wetted parts	Copper alloy
Data sheet	TM 48.01



A50
Standard version

Nominal size	63, 80, 100, 160 mm
Scale range	-30 ... +200 °C
Connection	Removable thermowell with retainer screw
Wetted parts	Copper alloy
Data sheet	TM 50.03



A52, R52
Industrial series, axial and radial

Nominal size	25, 33, 40, 50, 63, 80, 100, 160 mm
Scale range	-30 ... +50 to 0 ... +500 °C
Permissible operating pressure at thermowell/stem	Max. 25 bar
Wetted parts	Stainless steel
Data sheet	TM 52.01



TG53
Process version per ASME B40.200

Nominal size	3, 4, 5, 6"
Scale range	-70 ... +70 to 0 ... +600 °C
Wetted parts	Stainless steel
Option	Liquid damping to max. 250 °C (case and probe)
Data sheet	TM 53.02



TG54
Process version per EN 13190

Nominal size	63, 80, 100, 160 mm
Scale range	-70 ... +70 to 0 ... +600 °C
Wetted parts	Stainless steel
Option	Liquid damping to max. 250 °C (case and probe)
Data sheet	TM 54.02

Bimetal thermometers



55
High-quality process version per EN 13190

Nominal size	63, 100, 160 mm
Scale range	-70 ... +70 to 0 ... 600 °C
Wetted parts	Stainless steel
Option	Liquid damping to max. 250 °C (case and probe)
Data sheet	TM 55.01



TG58SA
Bimetal thermometer for sanitary applications

Nominal size	63, 80, 100, 130 mm
Scale range	-50 ... 50 °C to -20 ... 200 °C
Wetted parts	Stainless steel 316L
Option	<ul style="list-style-type: none"> Case filling with FDA-approved silicone oil Certification packages for food and pharmaceutical applications
Data sheet	TM 58.01

Machine glass thermometer



32
V shape

Nominal size	110, 150, 200 mm
Scale range	-30 ... +200 °C
Wetted parts	Copper alloy
Option	<ul style="list-style-type: none"> Dual scale °F/°C 2 variants: straight and 90°
Data sheet	TM 32.02

Expansion thermometers



TF58, TF59
With capillary, edgewise panel design

Nominal size	58 x 25 mm, 62 x 11 mm
Scale range	-50 ... 250 °C
Wetted parts	Copper alloy
Option	<ul style="list-style-type: none"> Vertical arrangement Special scales
Data sheet	TM 80.02



70
With capillary, stainless steel version

Nominal size	63, 100, 160 mm
Scale range	-60 ... +400 °C
Wetted parts	Stainless steel
Option	<ul style="list-style-type: none"> Liquid damping (case) Indication accuracy class 1
Data sheet	TM 81.01



IFC
With capillary, standard version

Nominal size	52, 60, 80, 100 mm 48 x 48, 72 x 72, 96 x 96 mm
Scale range	-100 ... +400 °C
Wetted parts	Copper alloy
Option	<ul style="list-style-type: none"> Square case version Other case materials
Data sheet	TM 80.01

Dial thermometers

Gas-actuated thermometers



R73, S73, A73

Axial and radial, adjustable stem and dial

Nominal size	100, 160 mm
Scale range	-200 ... +100 to 0 ... +700 °C
Wetted parts	Stainless steel
Option	<ul style="list-style-type: none"> ■ Liquid damping (case) ■ Contact bulb
Data sheet	TM 73.01



F73

With capillary

Nominal size	100, 160 mm
Scale range	-200 ... +100 to 0 ... +700 °C
Wetted parts	Stainless steel
Option	<ul style="list-style-type: none"> ■ Armoured or coated capillary (PVC coating) ■ Liquid damping (case) ■ Contact bulb
Data sheet	TM 73.01



75

Highly vibration-resistant

Nominal size	100 mm
Scale range	0 ... +700 or -50 ... +650 °C
Wetted parts	Stainless steel
Option	Various neck tube and insertion lengths
Data sheet	TM 75.01

Thermomanometers



MFT

With capillaries, for pressure and temperature measurement

Nominal size	40, 42, 52 mm
Scale range	<ul style="list-style-type: none"> ■ Pressure: 0 ... 4 bar ■ Temperature: 0 ... 120 °C
Accuracy class	<ul style="list-style-type: none"> ■ Pressure: 2.5 (EN 837-1) ■ Temperature: 2.5
Data sheet	PM 01.20



THM10

Eco version, for pressure and temperature measurement

Nominal size	63, 80 mm
Scale range	<ul style="list-style-type: none"> ■ Pressure: 0 ... 4 to 0 ... 10 bar ■ Temperature: 0 ... 120 °C
Connection location	Lower mount or back mount
Accuracy class	<ul style="list-style-type: none"> ■ Pressure: 2.5 (EN 837-1) ■ Temperature: 2 (EN 13190)
Data sheet	PM 01.24



100.02

For pressure and temperature measurement

Nominal size	63, 80 mm
Scale range	<ul style="list-style-type: none"> ■ Pressure: 0 ... 1 to 0 ... 16 bar ■ Temperature: 0 ... 100 to 0 ... 150 °C
Accuracy class	<ul style="list-style-type: none"> ■ Pressure: 2.5 (EN 837-1) ■ Temperature: 2.5 °C
Data sheet	PM 01.23

Dial thermometers with output signal



TGT73

Gas-actuated thermometer
with output signal

Nominal size	100, 160 mm
Scale range	-200 ... +100 to 0 ... 700 °C
Wetted parts	Stainless steel
Option	<ul style="list-style-type: none"> ■ Capillary ■ Liquid damping (case) ■ Output signal 4 ... 20 mA or 0 ... 10 V
Data sheet	TV 17.10

Digital indicators



DI10

For panel mounting, current loop display, 96 x 48 mm

Input	4 ... 20 mA, 2-wire
Alarm output	2 electronic contacts (optional)
Special feature	Wall-mounting case (optional)
Auxiliary power	Supply from the 4 ... 20 mA current loop
Data sheet	AC 80.06



DI30

For panel mounting, 96 x 96 mm

Input	Standard signals
Alarm output	2 relays
Special feature	<ul style="list-style-type: none"> ■ Integrated transmitter power supply ■ Wall-mounting case (optional)
Auxiliary power	AC 230 V or AC 115 V
Data sheet	AC 80.05



DI32-1

For panel mounting, 48 x 24 mm

Input	Multi-function input for resistance thermometers, thermocouples and standard signals
Alarm output	2 electronic contacts
Auxiliary power	DC 9 ... 28 V
Data sheet	AC 80.13



DI35

For panel mounting, 96 x 48 mm

Input	<ul style="list-style-type: none"> ■ Multi-function input for resistance thermometers, thermocouples and standard signals ■ Alternatively double input for standard signals with calculation function (+ - x /) for two transmitters
Alarm output	2 or 4 relays (optional)
Special feature	<ul style="list-style-type: none"> ■ Integrated transmitter power supply ■ Analogue output signal (optional)
Auxiliary power	<ul style="list-style-type: none"> ■ AC/DC 100 ... 240 V ■ DC 10 ... 40 V, AC 18 ... 30 V
Data sheet	AC 80.03



DIH10

Connection head with digital indicator

Input	4 ... 20 mA
Auxiliary power	Supply from the 4 ... 20 mA current loop
Data sheet	AC 80.11



DIH50, DIH52

For current loops with HART® communication

Dimension	150 x 127 x 127 mm
Case	Aluminium, stainless steel
Special feature	<ul style="list-style-type: none"> ■ Adjustment of display range and unit via HART® communication ■ Model DIH52 additionally suitable for multidrop operation and with local master function
Approval	<ul style="list-style-type: none"> ■ Intrinsically safe ■ Flameproof enclosure
Data sheet	AC 80.10



TF-LCD

Temperature probe for heating and refrigeration technology, with digital indicator

Measuring range	-40 ... +120 °C
Special feature	<ul style="list-style-type: none"> ■ Dust and waterproof case, IP68 ■ Battery or solar operation ■ Extremely long service life
Data sheet	TE 85.01

Thermocouples

Thermocouples generate a voltage directly dependent on temperature. They are particularly suitable for high temperatures to 1,700 °C (3,092 °F) and for very high oscillating stresses. For thermocouples, the accuracy classes per IEC 60584-1 and ASTM E230 apply.

In our range of products you will find all market-standard instrument versions. If required, a temperature transmitter can be installed in the connection head.



TC10-A
Measuring insert



Sensor element	Types K, J, E, N or T
Measuring range	-40 ... +1,200 °C, -40 ... +2,192 °F
Measuring location	Ungrounded or grounded
Data sheet	TE 65.01



TC10-B
For additional thermowell



Sensor element	Types K, J, E, N or T
Measuring range	-40 ... +1,200 °C, -40 ... +2,192 °F
Measuring location	Ungrounded or grounded
Data sheet	TE 65.02



TC10-C
Threaded, with protection tube



Sensor element	Types K, J, E, N or T
Measuring range	-40 ... +1,200 °C, -40 ... +2,192 °F
Measuring location	Ungrounded or grounded
Process connection	Mounting thread
Data sheet	TE 65.03



TC10-D
Threaded, miniature design



Sensor element	Types K, J, E, N or T
Measuring range	-40 ... +600 °C, -40 ... +1,112 °F
Measuring location	Ungrounded or grounded
Process connection	Mounting thread
Data sheet	TE 65.04



TC10-F
Flanged thermocouple, with protection tube



Sensor element	Types K, J, E, N or T
Measuring range	-40 ... +1,200 °C, -40 ... +2,192 °F
Measuring location	Ungrounded or grounded
Process connection	Flange
Data sheet	TE 65.06



TC10-H
Without thermowell



Sensor element	Types K, J, E, N or T
Measuring range	-40 ... +1,200 °C, -40 ... +2,192 °F
Measuring location	Ungrounded or grounded
Process connection	Mounting thread
Data sheet	TE 65.08



TC10-K
Measuring insert,
for installation in TC10-L

Sensor element	Types K, J, E, N or T
Measuring range	-40 ... +1,200 °C, -40 ... +2,192 °F
Measuring location	Ungrounded or grounded
Data sheet	TE 65.11



TC10-L
Flameproof enclosure,
for additional thermowell

Sensor element	Types K, J, E, N or T
Measuring range	-40 ... +1,200 °C, -40 ... +2,192 °F
Measuring location	Ungrounded or grounded
Data sheet	TE 65.12



TC12-A
Measuring insert for
process thermocouple

Sensor element	Types K, J, N or T
Measuring range	-40 ... +1,200 °C, -40 ... +2,192 °F
Measuring location	Ungrounded or grounded
Data sheet	TE 65.16

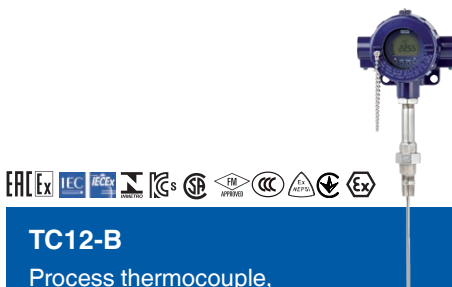

TC12-B
Process thermocouple,
for additional thermowell

Sensor element	Types K, J, E, N or T
Measuring range	-40 ... +1,200 °C, -40 ... +2,192 °F
Measuring location	Ungrounded or grounded
Option	Ex i, Ex d
Data sheet	TE 65.17

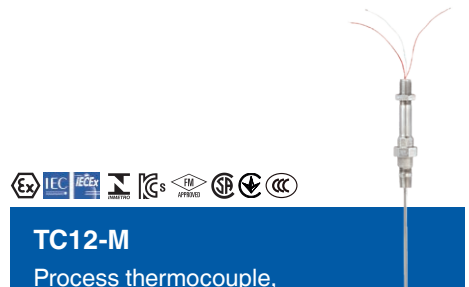

TC12-M
Process thermocouple,
basic module

Sensor element	Types K, J, E, N or T
Measuring range	-40 ... +1,200 °C, -40 ... +2,192 °F
Measuring location	Ungrounded or grounded
Option	Ex i, Ex d
Data sheet	TE 65.17

Thermocouples

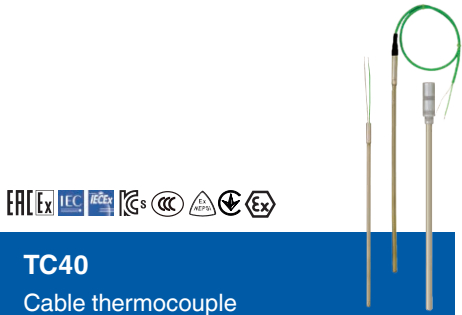

TC40
Cable thermocouple

Sensor element	Types K, J, E, N or T
Measuring range	-40 ... +1,200 °C, -40 ... +2,192 °F
Measuring location	Ungrounded or grounded
Cable	Silicone, PTFE/PFA, fibreglass
Data sheet	TE 65.40



TC46
Hot runner thermocouple

Sensor element	Types J or K
Measuring range	-25 ... +400 °C, -13 ... +752 °F
Measuring location	Ungrounded or grounded
Special feature	<ul style="list-style-type: none"> ■ Probe diameter 0.5 ... 3.0 mm ■ Plastic-moulded transition
Data sheet	TE 65.46

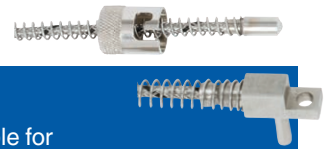

TC47
Thermocouple for plastics machinery

Sensor element	Types J or K
Measuring range	-25 ... +400 °C, -13 ... +752 °F
Measuring location	Ungrounded or grounded
Special feature	<ul style="list-style-type: none"> ■ Various process connections ■ Connection lead fibreglass with stainless steel braid
Data sheet	TE 67.20



TC50
Surface thermocouple

Sensor element	Types K, J, E, N or T
Measuring range	-40 ... +1,200 °C, -40 ... +2,192 °F
Measuring location	Ungrounded or grounded
Process connection	Surface mounting
Data sheet	TE 65.50

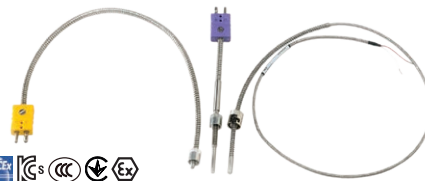

TC53
Bayonet thermocouple

Sensor element	Types K, J, N, E or T
Measuring range	-40 ... +1,200 °C, -40 ... +2,192 °F
Measuring location	Ungrounded or grounded
Special feature	<ul style="list-style-type: none"> ■ Single and dual thermocouple ■ Explosion-protected versions
Data sheet	TE 65.53



TC59-T
TEFRACTO-PAD®
Tubeskin thermocouple assembly

Sensor element	Types K, J, N, E
Measuring range	0 ... 1,260 °C, 32 ... 2,300 °F
Measuring location	Ungrounded or grounded
Process connection	Surface mounting, welded/shielded
Data sheet	TE 65.60



TC59-E
eTEFRACTO-PAD®
Tubeskin thermocouple assembly

Sensor element	Types K, J, N, E
Measuring range	0 ... 1,260 °C, 32 ... 2,300 °F
Measuring location	Ungrounded or grounded
Process connection	Surface mounting, extractable/shielded
Data sheet	TE 65.61



TC59-V
V-PAD®
Tubeskin thermocouple assembly

Sensor element	Types K, J, N, E
Measuring range	-25 ... +400 °C, -13 ... +752 °F
Measuring location	Ungrounded
Process connection	Surface mounting, welded
Data sheet	TE 65.59

Thermocouples

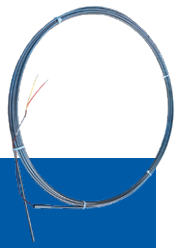

TCC
Linear sensor for hot spot detection

Sensor element	Type K thermocouple wires
Measuring range	0 ... 400 °C, 32 ... 752 °F
Special feature	<ul style="list-style-type: none"> ■ Continuous monitoring ■ Self-restoring ■ Passive element
Data sheet	TE 64.40



TC80
High-temperature thermocouple

Sensor element	Types S, R, B, K, N or J
Measuring range	0 ... 1,700 °C, 32 ... 3,092 °F
Measuring location	Ungrounded
Process connection	Stop flange, threaded bushing
Data sheet	TE 65.80



TC81
For flue gas temperature measurements

Sensor element	Types K, N or J
Measuring range	0 ... 1,200 °C, 32 ... 2,192 °F
Measuring location	Ungrounded or grounded
Process connection	Stop flange, threaded bushing
Data sheet	TE 65.81



TC82
High-temperature thermocouple

Sensor element	Types K, J, E, N, S, R or B
Measuring range	0 ... 1,700 °C, 32 ... 3,092 °F
Thermowell	C610, C799
Data sheet	TE 65.82



TC83
Calitum®
Sapphire-design thermocouple

Sensor element	Types K, J, E, N, S, R or B
Measuring range	0 ... 1,700 °C, 32 ... 3,092 °F
Thermowell	Sapphire (monocrystalline)
Data sheet	TE 65.83



TC84
Sapphire-design thermocouple

Sensor element	Types S, R, B
Measuring range	0 ... 1,700 °C, 32 ... 3,092 °F
Thermowell	Sapphire (monocrystalline)
Case	Highest safety thanks to 2-chamber system
Data sheet	TE 65.84



TC90
High-pressure thermocouple



Sensor element	Types K, J, E, N or T
Measuring range	0 ... 350 °C, 32 ... 662 °F
Measuring tip	Ungrounded or grounded
Process connection	Various high-pressure connections
Data sheet	TE 65.90



TC95
Multipoint thermocouple



Sensor element	Types K, J, E, N or T
Measuring range	0 ... 1,200 °C, 32 ... 2,192 °F
Measuring tip	Ungrounded or grounded
Process connection	Various process connections
Data sheet	TE 70.01

TC96-R
Flexible multipoint thermocouple



Sensor element	Types K, J, E or N
Measuring range	0 ... 1,200 °C, 32 ... 2,192 °F
Measuring tip	Ungrounded or grounded
Process connection	Various process connections
Data sheet	TE 70.10



TC96-O
Flexible multipoint thermometer for thermowells / protection tubes

Sensor element	Types K, J, E or N
Measuring range	0 ... 1,200 °C, 32 ... 2,192 °F
Measuring tip	Ungrounded or grounded
Process connection	Various process connections
Data sheet	TE 70.11

Resistance thermometers

Resistance thermometers are equipped with platinum sensor elements which change their electrical resistance as a function of temperature. In our range of products you will find resistance thermometers with connected cable as well as versions with connection head. A temperature transmitter can be installed directly in the connection head.

Resistance thermometers are suitable for applications between $-196 \dots +600 \text{ }^{\circ}\text{C}$, $[-320 \dots +1,112 \text{ }^{\circ}\text{F}]$ (dependent on instrument model, sensor element, accuracy class and wetted materials).

Resistance thermometers are available in classes AA, A and B in accordance with IEC 60751.



TR10-A
Measuring insert,
MIMS cable



Sensor element	1 x Pt100, 2 x Pt100
Measuring range	$-196 \dots +600 \text{ }^{\circ}\text{C}$, $-320 \dots +1,112 \text{ }^{\circ}\text{F}$
Connection method	2-, 3- and 4-wire
Measuring insert	MIMS cable
Data sheet	TE 60.01



TR10-B
For additional thermowell



Sensor element	1 x Pt100, 2 x Pt100
Measuring range	$-196 \dots +600 \text{ }^{\circ}\text{C}$, $-320 \dots +1,112 \text{ }^{\circ}\text{F}$
Connection method	2-, 3- and 4-wire
Measuring insert	MIMS cable
Data sheet	TE 60.02



TR10-C
Threaded, with protection tube



Sensor element	1 x Pt100, 2 x Pt100
Measuring range	$-196 \dots +600 \text{ }^{\circ}\text{C}$, $-320 \dots +1,112 \text{ }^{\circ}\text{F}$
Connection method	2-, 3- and 4-wire
Process connection	Mounting thread
Data sheet	TE 60.03



TR10-D
Threaded, miniature design



Sensor element	1 x Pt100, 2 x Pt100
Measuring range	$-196 \dots +500 \text{ }^{\circ}\text{C}$, $-320 \dots +932 \text{ }^{\circ}\text{F}$
Connection method	2-, 3- and 4-wire
Process connection	Mounting thread
Data sheet	TE 60.04



TR10-F
Flanged resistance thermometer,
with protection tube



Sensor element	1 x Pt100, 2 x Pt100
Measuring range	$-196 \dots +600 \text{ }^{\circ}\text{C}$, $-320 \dots +1,112 \text{ }^{\circ}\text{F}$
Connection method	2-, 3- and 4-wire
Process connection	Flange
Data sheet	TE 60.06



TR10-H
Without thermowell



Sensor element	1 x Pt100, 2 x Pt100
Measuring range	$-196 \dots +600 \text{ }^{\circ}\text{C}$, $-320 \dots +1,112 \text{ }^{\circ}\text{F}$
Connection method	2-, 3- and 4-wire
Process connection	Mounting thread
Measuring insert	MIMS cable
Data sheet	TE 60.08



TR11-A
Measuring insert, tubular design

Sensor element	1 x Pt100, 2 x Pt100
Measuring range	-50 ... +250 °C, -58 ... +482 °F
Connection method	2-, 3- and 4-wire
Measuring insert	Tubular design
Data sheet	TE 60.13



TR10-K
Measuring insert,
for installation in TR10-L

Sensor element	1 x Pt100, 2 x Pt100
Measuring range	-196 ... +600 °C, -320 ... +1,112 °F
Connection method	2-, 3- and 4-wire
Measuring insert	MIMS cable
Data sheet	TE 60.11



TR10-L
Flameproof enclosure,
for additional thermowell

Sensor element	1 x Pt100, 2 x Pt100
Measuring range	-196 ... +600 °C, -320 ... +1,112 °F
Connection method	2-, 3- and 4-wire
Measuring insert	MIMS cable
Data sheet	TE 60.12



TR12-A
Measuring insert for process
resistance thermometer TR12-B

Sensor element	1 x Pt100, 2 x Pt100
Measuring range	-196 ... +600 °C, -320 ... +1,112 °F
Connection method	2-, 3- and 4-wire
Measuring insert	MIMS cable
Data sheet	TE 60.16



TR12-B
Process resistance thermometer,
for additional thermowell

Sensor element	1 x Pt100, 2 x Pt100
Measuring range	-196 ... +600 °C, -320...+1,112 °F
Connection method	2-, 3- and 4-wire
Measuring insert	MIMS cable
Option	Ex i, Ex d
Data sheet	TE 60.17



TR12-M
Process resistance thermometer,
basic module

Sensor element	1 x Pt100, 2 x Pt100
Measuring range	-196 ... +600 °C, -320 ... +1,112 °F
Connection method	2-, 3- and 4-wire
Measuring insert	MIMS cable
Option	Ex i, Ex d
Data sheet	TE 60.17

Resistance thermometers



TFT35
Threaded temperature probe with integrated transmitter

Measuring range	-50 ... +200 °C
Special feature	<ul style="list-style-type: none"> ■ Output signal 4 ... 20 mA, 0 ... 10 V ■ Factory configured ■ Electr. connection via plug connection
Data sheet	TE 76.18



TR36
Compact version

Sensor element	1 x Pt100, 1 x Pt1000
Measuring range	-50 ... +250 °C, -58 ... +482 °F
Output	Pt100, 4 ... 20 mA
Data sheet	TE 60.36



TR31
OEM miniature design

Sensor element	1 x Pt100, 1 x Pt1000
Measuring range	-50 ... +250 °C, -58 ... +482 °F
Output	Pt100, Pt1000, 4 ... 20 mA
CSA	Ordinary and hazardous locations
Data sheet	TE 60.31



TR33
Miniature design, standard version

Sensor element	1 x Pt100, 1 x Pt1000
Measuring range	-50 ... +250 °C, -58 ... +482 °F
Output	Pt100, Pt1000, 4 ... 20 mA
CSA	Ordinary locations
Data sheet	TE 60.33



TR34
Miniature design, explosion-protected

Sensor element	1 x Pt100, 1 x Pt1000
Measuring range	-50 ... +250 °C, -58 ... +482 °F
Output	Pt100, Pt1000, 4 ... 20 mA
CSA	Hazardous locations
Data sheet	TE 60.34

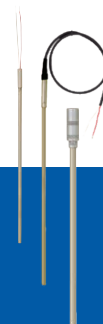

TR40
Cable resistance thermometer, MIMS cable

Sensor element	1 x Pt100, 2 x Pt100
Measuring range	-196 ... +600 °C, -320 ... +1,112 °F
Connection method	2-, 3- and 4-wire
Cable	Silicone, PTFE, PFA
Data sheet	TE 60.40



TR41
Cable resistance thermometer
Tubular design

Sensor element	1 x Pt100, 2 x Pt100
Measuring range	-60 ... +250 °C, -76 ... +482 °F
Connection method	2-, 3- and 4-wire
Cable	Silicone, PTFE, PFA
Data sheet	TE 60.41



TR50
Surface resistance thermometer

Sensor element	1 x Pt100, 2 x Pt100
Measuring range	-196 ... +600 °C, -320 ... +1,112 °F
Connection method	2-, 3- and 4-wire
Process connection	Surface mounting
Data sheet	TE 60.50

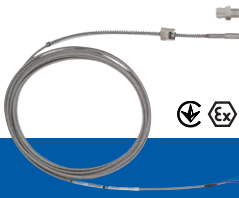

TR53
Bayonet resistance thermometer

Sensor element	1 x Pt100, 2 x Pt100
Measuring range	-196 ... +400 °C, -320 ... +752 °F
Connection method	2-, 3- and 4-wire
Process connection	Bayonet
Data sheet	TE 60.53



TR55
With spring-loaded tip

Sensor element	1 x Pt100, 2 x Pt100
Measuring range	-196 ... +500 °C, -320 ... +932 °F
Connection method	2-, 3- and 4-wire
Process connection	Compression fitting
Data sheet	TE 60.55



TR60
Indoor and outdoor resistance thermometer

Sensor element	1 x Pt100, 2 x Pt100
Measuring range	-40 ... +80 °C, -40 ... +176 °F
Connection method	2-, 3- and 4-wire
Process connection	Wall mounting
Data sheet	TE 60.60



TR75
DiwiTherm®
with digital indicator

Measuring range	-40.0 ... +199.9 °C, +200 ... +450 °C with automatic measuring range changeover (autorange)
Power supply	Battery operation
Data sheet	TE 60.75



TR81
For flue gas temperature
measurements

Sensor element	1 x Pt100, 2 x Pt100
Measuring range	-196 ... +600 °C, -320 ... +1,112 °F
Connection method	2-, 3- and 4-wire
Thermowell	Metal
Data sheet	TE 60.81



TR95
Multipoint resistance
thermometer

Sensor	Pt100
Measuring range	-196 ... +600 °C, -320 ... +1,112 °F
Connection method	2-, 3- and 4-wire
Process connection	Various process connections
Data sheet	TE 70.01

Resistance thermometers



TF35

Threaded temperature probe with plug connection

Measuring range -50 ... +250 °C

Measuring element Pt1000, Pt100, NTC, KTY

- Special feature
- Very high vibration resistance
 - Compact design
 - Electrical connection via plug connection

Data sheet TE 67.10



TF37

Threaded temperature probe with connection lead

Measuring range -50 ... +260 °C

Measuring element Pt100, Pt1000, NTC, KTY, Ni1000

- Special feature
- High vibration resistance
 - Connection lead made of PVC, silicone, PTFE
 - Brass or stainless steel thermowell

Data sheet TE 67.12



TF41

Temperature probe for outdoor temperature measurement

Measuring range -40 ... +100 °C

Measuring element Pt100, Pt1000, NTC

- Special feature
- Smallest case design, UV-resistant
 - Protected against dust and water jets, IP65
 - Clip-on sun protector

Data sheet TE 67.17

TF-2000

Cable temperature probe for heating and refrigeration technology

Measuring range -50 ... +105 °C

Measuring element Pt100, Pt1000, NTC

- Special feature
- Permanently protected against condensation
 - Cost savings thanks to quick assembly
 - Delivery reliability, even for large orders

Data sheet TE 67.40



TF44

Cable temperature probe for tubeskin measurement

Measuring range -50 ... +200 °C

Measuring element Pt100, Pt1000, NTC, KTY

- Special feature
- Connection lead from PVC, silicone
 - Aluminium probe sleeve
 - Protected against dust and water jets, IP65
 - With quick-mounting bracket

Data sheet TE 67.14



TF45

Cable temperature probe for general industrial applications

Measuring range -50 ... +260 °C

Measuring element Pt100, Pt1000, NTC, KTY, Ni1000

- Special feature
- Connection lead made of PVC, silicone, PTFE
 - Probe sleeve from stainless steel
 - Protected against dust and water jets, IP65

Data sheet TE 67.15



Temperature transmitters



T15
Digital temperature transmitter for resistance sensors

Input	Resistance thermometers, potentiometers
Accuracy	< 0.1 %
Output	4 ... 20 mA
Special feature	The fastest and simplest configuration on the market
Data sheet	TE 15.01



T16
Digital temperature transmitter for thermocouples

Input	All commercially available thermocouples
Accuracy	Typical < 2 K
Output	4 ... 20 mA
Special feature	The fastest and simplest configuration on the market
Data sheet	TE 16.01



T38
Digital temperature transmitter with HART® protocol

Input	Universal use for 1 or 2 sensors: resistance thermometers (up to 2 x 3-wire), thermocouples, potentiometers, reed chains
Accuracy	< 0.1 %
Output	4 ... 20 mA, HART® protocol
Special feature	TÜV-certified SIL version (full assessment), True Drift Detection technology
Data sheet	TE 38.01



T32
Digital temperature transmitter with HART® protocol

Input	Resistance thermometers, thermocouples, potentiometers
Accuracy	< 0.1 %
Output	4 ... 20 mA, HART® protocol
Special feature	TÜV-certified SIL version (full assessment)
Data sheet	TE 32.04



T91
Analogue temperature transmitter

Input	Resistance thermometers, thermocouples
Accuracy	< 0.5 or < 1 %
Output	0 ... 10 V, 4 ... 20 mA
Special feature	Fixed measuring range
Data sheet	TE 91.01, TE 91.02



TIF50, TIF52
HART® field temperature transmitter

Input	Resistance thermometers, thermocouples, potentiometers
Accuracy	< 0.1 %
Output	4 ... 20 mA, HART® protocol
Special feature	PC configurable
Data sheet	TE 62.01

Temperature switches

Temperature switches for industrial applications



TSD-30
Electronic temperature switch with display

Measuring range -20 ... +80 °C, -20 ... +120 °C, 0 ... 150 °C

Output

- Switching outputs PNP or NPN
- 4 ... 20 mA
- 0 ... 10 V
- IO-Link 1.1

Data sheet TE 67.03



TFS35
Bimetal temperature switch for switching voltages to 48 V

Switching temperature 50 ... 155 °C, fixed

Special feature

- Switching voltage to AC 48 V, DC 24 V
- Compact version: Normally closed (NC), normally open (NO)
- Electr. connection via plug connection

Data sheet TV 35.01



TFS135
Bimetal temperature switch for switching voltages to 250 V

Switching temperature 50 ... 130 °C, fixed

Special feature

- Switching voltages to AC 250 V
- Contact version normally closed (NC)
- Electr. connection via plug connection
- 1 or 2 switch contacts
- Option: With measuring element Pt1000 / Pt100

Data sheet TV 35.02

Temperature switches for the process industry



TXS, TXA
Mini temperature switches

Setting range -15 ... +20 to 180 ... 250 °C

Ignition protection type Ex ia or Ex d

Switch 1 x SPDT

Switching power AC 220 V/5 A
DC 24 V/5 A

Data sheet TV 31.70, TV 31.72



TCS, TCA
Compact temperature switches

Setting range -30 ... +10 to 160 ... 250 °C

Ignition protection type Ex ia or Ex d

Switch 1 x SPDT or 1 x DPDT

Switching power AC 250 V/15 A
DC 24 V/2 A

Data sheet TV 31.64, TV 31.65



TWG, TAG
Heavy-duty version

Setting range -30 ... +70 to 0 ... 600 °C

Ignition protection type Ex ia or Ex d

Switch 1 or 2 SPDT or 1 x DPDT

Switching power AC 250 V/20 A
DC 24 V/2 A

Data sheet TV 31.60, TV 31.61

Thermometers with switch contacts



SC15

Expansion thermometer with microswitch, indicating temperature controller

Nominal size 60, 80, 100 mm
72 x 72, 96 x 96 mm

Scale range -100 ... +400 °C

Wetted parts Copper alloy

Option Sheet steel version

Data sheet TV 28.02



SB15

Expansion thermometer with microswitch, safety temperature limiter

Nominal size 60, 80, 100 mm
72 x 72, 96 x 96 mm

Scale range 0 ... 400 °C

Wetted parts Copper alloy

Option ■ Sheet steel version

Data sheet TV 28.03



TGS55

Bimetal thermometer, stainless steel version

Nominal size 100 mm

Scale range -70 ... +30 to 0 ... 600 °C

Wetted parts Stainless steel

Option Liquid damping to max. 250 °C (case and probe)

Data sheet TV 25.01



TGS73

Gas-actuated thermometer, stainless steel version

Nominal size 100, 160 mm

Scale range -200 ... +100 to 0 ... 700 °C

Wetted parts Stainless steel

Option ■ Capillary
■ Liquid damping (case)

Data sheet TV 27.01



70 with 8xx

Expansion thermometer with microswitch

Nominal size 100 mm

Scale range -60 ... +40 to 0 ... 250 °C

Wetted parts Stainless steel

Option Various contact versions

Data sheet TV 28.01

Temperature controllers



CS4R

For rail mounting,
22.5 x 75 mm

Input	Multi-function input for resistance thermometers, thermocouples and standard signals
Control mode	PID, PI, PD, P, ON/OFF (configurable)
Monitoring output	Relay or logic level DC 0/12 V to control an electronic switch relay (SSR) or analogue current signal 4 ... 20 mA
Auxiliary power	<ul style="list-style-type: none"> ■ AC 100 ... 240 V ■ AC/DC 24 V
Data sheet	AC 85.05



CS6S, CS6H, CS6L

For panel mounting,
48 x 48, 48 x 96, 96 x 96 mm

Input	Multi-function input for resistance thermometers, thermocouples and standard signals
Control mode	PID, PI, PD, P, ON/OFF (configurable)
Monitoring output	Relay (AC 250 V, 3A, (R) or 1A (L)) or logic level DC 0/12 V for 3-point control to control an electronic switch relay (SSR) or analogue current signal 4 ... 20 mA
Auxiliary power	<ul style="list-style-type: none"> ■ AC 100 ... 240 V ■ AC/DC 24 V
Data sheet	AC 85.08

Accessories



TND

Display for
T38 temperature transmitter

Input	4 ... 20 mA
Dimension	Ø 44 mm
Scale range	13.5 x 28 mm
Special feature	<ul style="list-style-type: none"> ■ 5-digit main measured value display ■ 2 variants: with clip-on adapter or remote for mounting in the connection head cover (BSZ-H)
Data sheet	TE 38.01



IR80

Installation rods

For installation of high-temperature thermocouples
Suited for horizontal and vertical installation
Can be used with flanged thermocouples
Combines high mechanical stability and low weight



PP82

Purge-gas control panel

Heavy-duty stainless steel version
High mechanical stability through side protection
For wall and pipe mounting, 2"
Pressure gauge with liquid damping
Data sheet AC 80.19

Accessories



PU-548

Programming unit for temperature transmitters

Special feature

- LED status display
- Compact design
- No further voltage supply needed, neither for the programming unit nor for the transmitter
- Due to the magWIK quick connector, fast connection to the transmitter possible

Data sheet

AC 80.18



magWIK

Magnetic quick connector

Special feature

- For accelerated connection for all configuration and calibration processes
- Connection of 2-mm plug contacts or 4-mm plug contacts with adapter

Data sheet

AC 80.15

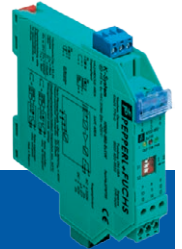

904

Control unit for inductive contacts

Application

For operating measuring instruments with inductive contacts

Data sheet

AC 08.04



Coupler connectors



Fittings

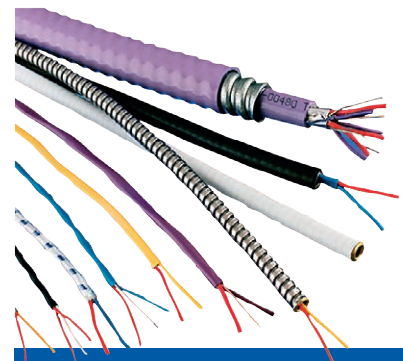

Wires and cables

Thermowells / Protection tubes

Whether in aggressive or abrasive process media, whether in high- or low-temperature ranges: For electrical or mechanical thermometers, to prevent direct exposure of their temperature probes to the medium, thermowells / protection tubes that suit each application are available. Thermowells / Protection tubes can be machined from bar stock material or assembled from tube sections and can either be screw-, weld- or flange-fitted.

They are offered in standard and special materials such as stainless steel 1.4571, 316L, Hastelloy® or titanium. Each version, depending on its construction type and its mounting to the process, has certain advantages and drawbacks with respect to its load limits and the special materials that can be used.

In order to manufacture thermowells / protection tubes for flange mounting at low cost from special materials, the designs used differ from standard thermowells/protection tubes in accordance with DIN 43772.

Thus, only the wetted parts of the thermowell / protection tube are manufactured from special materials, whereas the non-wetted flange is made of stainless steel and is welded to the special material.

This design is used both for protection tubes and thermowells. With tantalum as special material a removable jacket is used, which is slid over the supporting thermowell / protection tube from stainless steel.



TW10
Thermowell with flange

Thermowell form	Tapered, straight or stepped
Nominal width	■ ASME 1 ... 4" DIN/EN ■ DN 25 ... 100
Pressure rating	ASME to 2,500 lb (DIN/EN to PN 100)
Data sheet	TW 95.10, TW 95.11, TW 95.12



TW15
Threaded thermowell

Thermowell form	Tapered, straight or stepped
Head design	Hexagon, round with hexagon, or round with spanner flats
Process connection	½, ¾ or 1 NPT
Data sheet	TW 95.15



TW20
Weld-in thermowell for welding socket

Thermowell form	Tapered, straight or stepped
Welding diameter	1.050, 1.315 or 1.900" (26.7, 33.4 or 48.3 mm)
Pressure rating	3,000 or 6,000 psi
Data sheet	TW 95.20



TW25
Weld-in thermowell

Thermowell form	Tapered, straight or stepped
Bar diameter	Up to 2" (50.8 mm)
Data sheet	TW 95.25



TW30
Vanstone, thermowell for lap flanges

Thermowell form	Tapered, straight or stepped
Nominal width	ASME 1, 1½ or 2"
Pressure rating	ASME up to 2,500 lb
Data sheet	TW 95.30



TW31
Vanstone design in accordance with petrochemical standard

Thermowell form	In accordance with Shell drawings S38.113 and S38.114
Material	Stainless steel, special alloys
Flange	Slip-on flanges per ASME B16.5
Data sheet	TW 95.31



ScrutonWell®
Thermowells
in ScrutonWell® design

Thermowell form	Bar stock material or with welded-on helix
Process connection	Flange, threaded or weld-in
Material	Stainless steel or special materials
Data sheet	SP 05.16



TW35
Threaded protection
tube (DIN 43772 form 2, 2G, 3, 3G)

Protection tube form	Form 2, 2G, 3 or 3G
Material	Stainless steel
Connection to thermometer	M24 x 1.5 rotatable
Data sheet	TW 95.35



TW40
Protection tube with flange
(DIN 43772 form 2F, 3F)

Protection tube form	Form 2F or 3F
Nominal width	■ DIN/EN DN 25 ... 50 ■ ASME 1 ... 2"
Pressure rating	■ DIN/EN up to PN 100 ■ ASME up to 1,500 psig
Data sheet	TW 95.40



TW45
Threaded protection tube
(DIN 43772 form 5, 8)

Protection tube form	Form 5 or 8
Material	Stainless steel
Data sheet	TW 95.45



TW50
Threaded thermowell
(DIN 43772 form 6, 7, 9)

Thermowell form	Form 6, 7 or 9
Data sheet	TW 95.50



TW55
Thermowell for weld-in or
with flange (DIN 43772 form 4, 4F)

Thermowell form	Form 4 or 4F
Nominal width	■ DIN/EN DN 25 ... 50 ■ ASME 1 ... 2"
Pressure rating	■ DIN/EN up to PN 100 ■ ASME up to 2,500 psig
Data sheet	TW 95.55

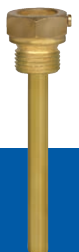

SWT52G, SWT52S
Protection tube for model 52

Connection to thermometer	Suitable for thermometers with plain connection (without thread), collar Ø 18 mm, stem 8 and 13 mm
Protection tube material	Copper alloy, St35 or stainless steel
Process connection	G ½ B thread
Max. process temperature, process pressure	■ 160 °C with copper alloy as protection tube material (6 bar stat.) ■ 500 °C with St35 stainless steel as protection tube material (25 bar stat.)
Data sheet	TW 90.11

Bypass level indicators

Continuous level measurement via visual indication of the level without auxiliary power

Applications

- Continuous level indication without auxiliary power
- Indication of the level proportional to height
- Individual design and corrosion-resistant materials make the products suitable for a broad range of applications
- Chemical industry, petrochemical industry, oil and natural gas extraction (on- and offshore), shipbuilding, machine building, power generating equipment, power plants
- Process water and drinking water treatment, food and beverage industry, pharmaceutical industry



Special features

- Process- and procedure-specific production
- Operating limits:
 - Operating temperature: $T = -196 \dots +450 \text{ }^\circ\text{C}$
 - Operating pressure: $P = \text{vacuum to } 400 \text{ bar}^1$
 - Limit density: $\rho \geq 340 \text{ kg/m}^3$
- Wide variety of different process connections and materials
- Mounting of level transmitters and magnetic switches possible as an option
- Explosion-protected versions

¹⁾ Individual limit values. For application limits, the joint consideration of temperature and pressure is required.

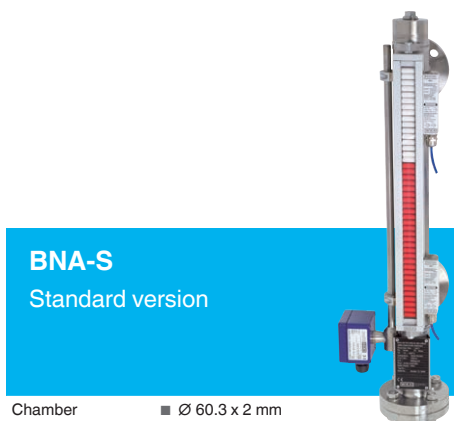

BNA-S
Standard version

Chamber

- $\varnothing 60.3 \times 2 \text{ mm}$
- $\varnothing 60.3 \times 2.77 \text{ mm}$

Material

- Stainless steel 1.4571/316Ti
- 1.4401/1.4404 (316/316L)

Process connection

- Flange DIN, ANSI, EN
- Thread
- Weld stub

Pressure Max. 100 bar

Temperature $-196 \dots +450 \text{ }^\circ\text{C}$

Data sheet LM 10.01

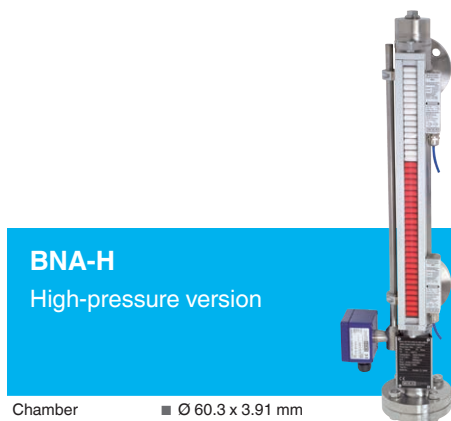

BNA-H
High-pressure version

Chamber

- $\varnothing 60.3 \times 3.91 \text{ mm}$
- $\varnothing 60.3 \times 5.54 \text{ mm}$
- $\varnothing 73 \times 7.01 \text{ mm}$
- $\varnothing 76.1 \times 5 \text{ mm}$
- $\varnothing 71 \times 7.5 \text{ mm}$
- $\varnothing 76 \times 10 \text{ mm}$

Material 1.4401/1.4404 (316/316L)

Process connection

- Flange DIN, ANSI, EN
- Thread
- Weld stub

Pressure Max. 385 bar

Temperature $-196 \dots +450 \text{ }^\circ\text{C}$

Data sheet LM 10.01



BNA-X
Special materials

Chamber

- $\varnothing 60.3 \times 2 \text{ mm}$
- $\varnothing 60.3 \times 2.77 \text{ mm}$
- $\varnothing 60.3 \times 3.91 \text{ mm}$
- $\varnothing 60.3 \times 5.54 \text{ mm}$

Material

- Titanium 3.7035
- Hastelloy C276
- 6Mo 1.4547
- Monel
- Inconel

Process connection

- Flange DIN, ANSI, EN
- Thread
- Weld stub

Pressure Max. 250 bar

Temperature $-196 \dots +450 \text{ }^\circ\text{C}$

Data sheet LM 10.01

BNA-P

Plastic version



Chamber	Ø 60.3 x 3 mm
Material	<ul style="list-style-type: none"> ■ PVDF ■ PP
Process connection	Flange DIN, ANSI, EN
Pressure	Max. 6 bar
Temperature	-10 ... +100 °C
Data sheet	LM 10.01

BNA-L

Liquid/KOplus version



Chamber	<ul style="list-style-type: none"> ■ Ø 88.9 x 2 mm ■ Ø 88.9 x 2.9 mm ■ 114 x 2 mm ■ 114 x 3.6 mm ■ 114 x 4.5 mm ■ 114 x 6.3 mm
Material	1.4401/1.4404 (316/316L)
Process connection	<ul style="list-style-type: none"> ■ Flange DIN, ANSI, EN ■ Thread ■ Weld stub
Pressure	Max. 63 bar
Temperature	-196 ... +450 °C
Data sheet	LM 10.01

BNA-SD, BNA-HD DUplus

Standard/High-pressure version



Chamber	<ul style="list-style-type: none"> ■ BNA-SD: Ø 60.3 x 2 mm <li style="padding-left: 20px;">Ø 60.3 x 2.77 mm ■ BNA-HD: Ø 60.3 x 3.91 mm
Material	■ 1.4401/1.4404 (316/316L)
Process connection	<ul style="list-style-type: none"> ■ Flange DIN, ANSI, EN ■ Thread ■ Weld stub
Pressure	<ul style="list-style-type: none"> ■ BNA-SD: max. 100 bar ■ BNA-HD: max. 160 bar
Temperature	-196 ... +450 °C
Data sheet	LM 10.01

Accessories for bypass level indicators



BLR

Reed level transmitter



Material	Stainless steel
Meter run	Max. 6,000 mm
Temperature	-100 ... +350 °C, depending on version
Output signal	4 ... 20 mA, HART®, PROFIBUS® PA or FOUNDATION™ Fieldbus
Data sheet	LM 10.03

BMD

Magnetic indication



Material	Aluminium, anodised, stainless steel
Indication elements	Plastic rollers, stainless steel flaps
Cover	Polycarbonate, glass
Length	180 ... 6,000 mm
Temperature	-200 ... +450 °C
Data sheet	LM 10.03

BFT

Float



Material	Stainless steel, titanium, various special materials
Pressure	To 450 bar
Temperature	-200 ... +450 °C
Density	> 340 kg/m ³
Data sheet	LM 10.02

Accessories for bypass

Combines the tried-and-trusted bypass with further independent measurement principles



BLM-SI, BLM-SD
Magnetostrictive level transmitter, intrinsically safe (Ex i)

Material	Stainless steel 1.4404
Guide tube length	Max. 5,800 mm
Temperature	-60 ... +185 °C
Output signal	4 ... 20 mA, HART®
Data sheet	LM 10.05



BLM-SF-FM
Magnetostrictive level transmitter with FM approval

Material	Stainless steel
Guide tube length	Max. 4,000 mm
Temperature	-200 ... +180 °C
Output signal	4 ... 20 mA, HART®
Data sheet	LM 10.05



UTN
Top-mounted level indicator

Chamber	<ul style="list-style-type: none"> ■ Ø 42.4 x 2 mm (standard) ■ Ø 42.2 x 2.77 mm ■ Ø 60.3 x 2 mm ■ Ø 60.3 x 2.77 mm
Material	<ul style="list-style-type: none"> ■ Stainless steel 1.4571/316Ti ■ Stainless steel 1.4401/1.4404 (316/316L)
Process connection	Flange DIN, ANSI, EN
Pressure	Max. 40 bar
Temperature	-196 ... +300 °C
Data sheet	LM 11.02



BLM-TA
High-temperature version

Material	Stainless steel
Guide tube length	Max. 6,000 mm
Temperature	<ul style="list-style-type: none"> ■ -40 ... +125 °C ■ -90 ... +125 °C ■ -45 ... +250 °C ■ -45 ... +450 °C
Output signal	4 ... 20 mA, HART® v6
Data sheet	LM 10.05



BLM-TAI
High-temperature version, intrinsically safe

Material	Stainless steel
Guide tube length	Max. 6,000 mm
Temperature	<ul style="list-style-type: none"> ■ -40 ... +125 °C ■ -40 ... +250 °C ■ -40 ... +450 °C
Output signal	4 ... 20 mA, HART® v6
Data sheet	LM 10.05



BLM-TBD
High-temperature version with LC display, intrinsically safe or flameproof enclosure

Material	Stainless steel
Guide tube length	Max. 6,000 mm
Temperature	<ul style="list-style-type: none"> ■ -65 ... +125 °C ■ -40 ... +85 °C ■ -40 ... +125 °C ■ -40 ... +250 °C ■ -40 ... +450 °C
Output signal	4 ... 20 mA, HART® v6
Ingress protection	IP68 per IEC/EN 60529

External chambers

The external chamber model BZG consists of an external chamber vessel that is mounted laterally to a container using at least 2 process connections (flange, thread or weld stub). Through this type of arrangement, the level in the external chamber vessel

corresponds to the level in the container. The level is measured by a measuring instrument inserted additionally in the external chamber vessel, for example model FLR or FLS, or by a guided wave radar.

Applications

- Level detection for almost all liquid media
- Individual design and corrosion-resistant materials make the products suitable for a broad range of applications
- Chemical industry, petrochemical industry, oil and natural gas extraction (on- and offshore), shipbuilding, machine building, power generating equipment, power plants

Special features

Process- and procedure-specific production

Operating limits: □ Operating temperature: $T = -196 \dots +450 \text{ }^{\circ}\text{C}$
 □ Operating pressure: $P = \text{Vacuum to } 400 \text{ bar}^{1)}$

- Wide variety of different process connections and materials
- Mounting of level transmitters and guided wave radars possible as an option

¹⁾ Individual limit values. For application limits, the joint consideration of temperature and pressure is required.

BZG-S

External chamber,
standard version

Material	<ul style="list-style-type: none"> ■ Stainless steel 1.4571 (316Ti) ■ Stainless steel 1.4401/1.4404 (316/316L)
Process connection	Flange <ul style="list-style-type: none"> ■ DIN EN 1092-1 DN 10 ... DN 100, PN 6 ... PN 63 ■ DIN DN 10 ... DN 100, PN 6 ... PN 64 ■ ANSI B16.5 ½" ... 4", class 150 ... 600
Pressure	64 bar
Temperature	-196 ... +450 °C
Data sheet	LM 11.01

BZG-H

External chamber,
high-pressure version

Material	<ul style="list-style-type: none"> ■ Stainless steel 1.4571 (316Ti) ■ Stainless steel 1.4401/1.4404 (316/316L)
----------	--

Process connection	Flange <ul style="list-style-type: none"> ■ DIN EN 1092-1 DN 10 ... DN 100, PN 100 ... PN 400 ■ DIN DN 10 ... DN 100, PN 100 ... PN 400 ■ ANSI B16.5 ½" ... 4", class 600 ... 2,500
--------------------	--

Pressure	400 bar
Temperature	-196 ... +450 °C
Data sheet	LM 11.01

BZG-K

External chamber,
steel version

Material	<ul style="list-style-type: none"> ■ Steel 1.0345/1.0460 ■ Steel 1.5415 (16Mo3) ■ A105/A106 Gr. B ■ A350 LF2/A333 Gr. 6
----------	---

Process connection	Flange <ul style="list-style-type: none"> ■ DIN EN 1092-1 DN 10 ... DN 50, PN 16 ... PN 400 ■ DIN DN 10 ... DN 50, PN 16 ... PN 400 ■ ANSI B16.5 ½" ... 4", class 150 ... 2,500
--------------------	--

Pressure	Max. 255 bar (material-dependent)
Temperature	-10 ... +425 °C (material-dependent)
Data sheet	LM 11.01

BZG-X

External chamber,
special material version

Material	<ul style="list-style-type: none"> ■ Stainless steel 6Mo 1.4547 (UNS S31254) ■ Stainless steel 1.4306 (304L) ■ Duplex 1.4462 (UNS S31803) ■ Super Duplex 1.4410 (UNS S3850) ■ Titanium 3.7035 (grade 2) ■ Hastelloy C276 (2.4819)
----------	---

Process connection	Flange <ul style="list-style-type: none"> ■ DIN EN 1092-1 DN 10 ... DN 100, PN 63 ... PN 400 ■ DIN DN 10 ... DN 100, PN 64 ... PN 400 ■ ANSI B16.5 ½" ... 4", class 600 ... 2,500
--------------------	--

Pressure	Max. 430 bar (material-dependent)
Temperature	-196 ... +450 °C (material-dependent)
Data sheet	LM 11.01

Glass level gauges

Direct level indication without auxiliary power

Applications

- Continuous level indication without auxiliary power
- Direct indication of the level
- Individual design and corrosion-resistant materials make the products suitable for a broad range of applications
- Chemical industry, petrochemical industry, oil and natural gas extraction (on- and offshore), shipbuilding, machine building, power generating equipment, power plants
- Oil and gas, heat transfer and refrigeration systems, plants for cryogenics



Special features

- Process- and procedure-specific production
- Operating limits:
 - Operating temperature: $T = -196 \dots +374 \text{ °C}$ ¹⁾
 - Operating pressure: vacuum to 250 bar ¹⁾
- Wide variety of different process connections and materials
- Illumination optional
- Heating and/or insulation optional

¹⁾ Individual limit values. For application limits, the joint consideration of temperature and pressure is required.

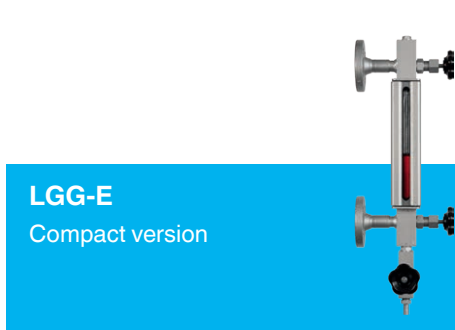

LGG-E
Compact version

Type of indication	Reflex
Material	<ul style="list-style-type: none"> ■ Steel 1.0460 ■ A105, 1.0570
Process connection	Flange DIN, ANSI, EN
Pressure	Max. 40 bar
Temperature	-10 ... +243 °C (steam)
Glass size	2 ... 11
Number of segments	1 ... 3
Data sheet	LM 33.01



LGG-RP, LGG-TP
Carbon-Line version

Type of indication	Reflex/transparent
Material	Steel A350 LF2
Process connection	<ul style="list-style-type: none"> ■ Flange DIN, ANSI, EN ■ Male thread 1/2" NPT, 3/4" NPT ■ Weld stub 1/2", 3/4"
Pressure	Max. 100 bar
Temperature	<ul style="list-style-type: none"> ■ -40 ... +243 °C (steam) ■ -40 ... +300 °C
Glass size	4 ... 9
Number of segments	1 ... 5
Data sheet	LM 33.01



LGG-RE, LGG-TE
Standard version

Type of indication	Reflex/transparent
Material	<ul style="list-style-type: none"> ■ Steel 1.0570, A350 LF2 ■ Stainless steel 1.4404/316L
Process connection	<ul style="list-style-type: none"> ■ Flange DIN, ANSI, EN ■ Male thread 1/2" NPT, 3/4" NPT ■ Weld stub 1/2", 3/4"
Pressure	Max. 160 bar
Temperature	<ul style="list-style-type: none"> ■ -196 ... +243 °C (steam) ■ -196 ... +300 °C
Glass size	2 ... 11
Number of segments	1 ... 5 (others on request)
Data sheet	LM 33.01

LGG-RI, LGG-TI

High-pressure version

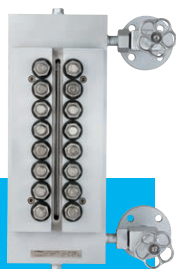

Type of indication Reflex/transparent

Material

- Steel 1.5415
- Stainless steel 1.4404/316L

Process connection

- Flange DIN, ANSI, EN
- Male thread 1/2" NPT, 3/4" NPT
- Weld stub 1/2", 3/4"

Pressure Max. 250 bar

Temperature -196 ... +100 °C

Glass size 2 ... 9

Number of segments 1 ... 5

Data sheet LM 33.01

LGG-M

Refraction version

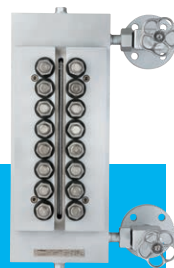

Type of indication Refraction

Material Steel 1.5415

Process connection

- Flange DIN, ANSI, EN
- Male thread G 1/2, G 3/4, 1/2" NPT, 3/4" NPT
- Weld stub 1/2", 3/4"

Pressure Max. 250 bar

Temperature -10 ... +374 °C

Glass size 2 ... 11

Number of segments 1 ... 9

Data sheet LM 33.01

LGI

Illumination unit,
for glass level gauge



Data sheet LM 33.02

Submersible pressure sensors

Hydrostatic level measurement



Applications

- Level measurement in rivers and lakes
- Control of sewage lift and pumping stations
- Monitoring of sewage, settling and rainwater retention basins
- Level measurement in vessel and storage systems for oils and fuels

Special features

- Slimline and hermetically sealed design to 300 m water column
- Highly resistant versions available
- Explosion protection per ATEX, IECEx, FM and CSA
- Drinking water conformity per KTW and ACS
- Temperature output, HART® and low-power output signal for battery operation



LS-1000 For general applications



Accuracy (± % of span) ≤ 0.5 or ≤ 1

Measuring range ■ 0 ... 0.1 to 0 ... 1 bar
■ 0 ... 1.25 to 0 ... 2 bar abs.

Special feature ■ Levels from 1 to 10 m
■ Permanently leak-tight
■ Low total cost of ownership

Data sheet LM 40.05



IL-10 Intrinsic safety Ex ia



Accuracy (± % of span) ≤ 0.5 or ≤ 0.25 (only applies to measuring ranges ≥ 0.25 bar (3.6 psi))

Measuring range 0 ... 0.1 to 0 ... 25 bar

Special feature ■ Suitable for all level measurements in hazardous areas
■ Explosion protection per IECEx, ATEX and CSA
■ Shipbuilding approval in accordance with GL

Data sheet PE 81.23



LF-1 For demanding applications, intrinsic safety Ex ia as an option

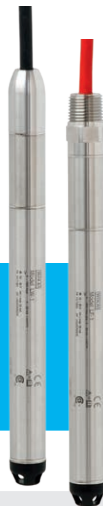

Accuracy (± % of span) ≤ 0.5 or ≤ 1

Measuring range ■ 0 ... 0.1 to 0 ... 6 bar
■ 0 ... 1.6 to 0 ... 6 bar abs.

Special feature ■ Suitable for measurements in contaminated and aggressive media
■ An optimised discharge behaviour and a large pressure port prevent the instrument from clogging and ensure a minimum maintenance effort
■ Can be used in explosion-protected areas
■ Developed for wireless applications

Data sheet LM 40.04



LH-10 For demanding applications



Accuracy (± % of span) Measuring range: < 0.25 bar: ≤ ±0.50 %
Measuring ranges: ≥ 0.25 bar: ≤ ±0.25 %

Measuring range 0 ... 0.1 to 0 ... 25 bar

Special feature ■ Precise and reliable
■ Integrated temperature measurement (option)
■ Design from Hastelloy® and FEP cable for especially high resistance (optional)

Data sheet PE 81.09

Continuous measurement with float for industrial applications

With reed measuring chain

Applications

- Level measurement of liquids in machine building
- Control and monitoring tasks for hydraulic power packs, compressors and cooling systems

Special features

- Media compatibility: Oil, water, diesel, refrigerants and other liquids
- Permissible medium temperature: -30 ... +120 °C
- Output signals for level and temperature (optional) as resistance output signal or 4 ... 20 mA current output
- Accuracy, resolution: 24, 12, 10, 6 or 3 mm



RLT-1000 Stainless steel version

Accuracy	24, 20, 12, 10, 6 or 3 mm
Output signal	<ul style="list-style-type: none"> ■ Resistance signal ■ 4 ... 20 mA, 2-wire ■ 0 ... 5 V, 3-wire ■ 0 ... 10 V, 3-wire
Temperature	-30 ... +80 °C (-30 ... +120 °C optional)
Guide tube length	150 ... 1,500 mm
Data sheet	LM 50.02



RLT-2000 Plastic version

Accuracy	24, 20, 12, 10, 6 or 3 mm
Output signal	<ul style="list-style-type: none"> ■ Resistance signal ■ 4 ... 20 mA, 2-wire ■ 0 ... 5 V, 3-wire ■ 0 ... 10 V, 3-wire
Temperature	-10 ... +80 °C (-30 ... +120 °C optional)
Guide tube length	150 ... 1,500 mm
Data sheet	LM 50.01



RLT-3000 Stainless steel version with temperature output signal

Accuracy	24, 20, 12, 10, 6 or 3 mm
Level output signal	<ul style="list-style-type: none"> ■ 4 ... 20 mA, 2-wire ■ 0 ... 5 V, 3-wire ■ 0 ... 10 V, 3-wire
Output signal	Pt100 or Pt1000
Temperature	-30 ... +100 °C
Guide tube length	150 ... 1,500 mm
Data sheet	LM 50.05



Continuous measurement with float for the process industry

Magnetostrictive

Applications

- High-accuracy level detection for almost all liquid media
- Chemical industry, petrochemical industry, natural gas, offshore, shipbuilding, machine building, power generating equipment, power plants
- Process water and drinking water treatment, food and beverage industry, pharmaceutical industry

Special features

- Process- and procedure-specific solutions possible
- Operating limits:
 - Operating temperature: $T = -90 \dots +450 \text{ }^\circ\text{C}$
 - Operating pressure: $P = \text{vacuum to } 100 \text{ bar}$
 - Limit density: $\rho \geq 400 \text{ kg/m}^3$
- Resolution $< 0.1 \text{ mm}$
- Wide variety of different electrical connections, process connections and materials
- Explosion-protected versions



FLM-TA Stainless steel version

Process connection ■ Mounting thread
■ Flange: DIN, ANSI

Guide tube length Max. 6,000 mm

Pressure 0 ... 200 bar

Temperature -90 ... +450 °C

Density $\geq 400 \text{ kg/m}^3$

Ingress protection IP66/IP68 per IEC/EN 60529

Data sheet LM 20.01



FLM-CAI Compact version, intrinsically safe

Process connection ■ Mounting thread downwards
- G 1/2" ... G 2"
- NPT 1/2" ... NPT 2"
■ Mounting flange
- ANSI 1/2" ... 2 1/2", class 150 ... 600
- EN DN 20 ... DN 65, PN 6 ... PN 100
- DIN DN 20 ... DN 65, PN 6 ... PN 100

Guide tube length ■ 100 ... 1,000 mm (Ø 6 mm guide tube)
■ 100 ... 3,000 mm (Ø 12 mm guide tube)

Pressure Vacuum to 40 bar

Temperature -40 ... +250 °C

Density $\geq 580 \text{ kg/m}^3$

Ingress protection IP68 per IEC/EN 60529

Data sheet LM 20.04

FLM-CM Compact version for industrial applications

Process connection Mounting thread downwards
- G 1/2" ... G 2"
- NPT 1/2" ... NPT 2"

Guide tube length 100 ... 1,000 mm (Ø 6 mm guide tube)

Pressure Vacuum to 40 bar

Temperature -40 ... +125 °C

Density $\geq 680 \text{ kg/m}^3$

Ingress protection IP68 per IEC/EN 60529

Data sheet LM 20.05

FLM-CA Compact version for process applications

Process connection ■ Mounting thread downwards
- G 1/2" ... G 2"
- NPT 1/2" ... NPT 2"
■ Mounting flange
- ANSI 1/2" ... 2 1/2", class 150 ... 600
- EN DN 20 ... DN 65, PN 6 ... PN 100
- DIN DN 20 ... DN 65, PN 6 ... PN 100

Guide tube length ■ 100 ... 1,000 mm (Ø 6 mm guide tube)
■ 100 ... 3,000 mm (Ø 12 mm guide tube)

Pressure Vacuum to 40 bar

Temperature -40 ... +250 °C

Density $\geq 580 \text{ kg/m}^3$

Ingress protection IP68 per IEC/EN 60529

Data sheet LM 20.04

FLM-P

Plastic version



Process connection ■ Mounting thread
■ Flange DIN, ANSI

Guide tube length Max. 5,000 mm

Pressure 0 ... 16 bar

Temperature -10 ... +100 °C

Density $\geq 800 \text{ kg/m}^3$

Ingress protection IP68 per IEC/EN 60529

Data sheet LM 20.01



FLM-H

Hygienic version, for sanitary applications



Process connection ■ Clamp ISO 2852
■ Clamp DIN 32767
■ Aseptic thread DIN 11864-1
■ Aseptic liner DIN 11864-1
■ Aseptic flange DIN 11864-2
■ Aseptic clamp DIN 11864-3
■ VARIVENT®
■ BioConnect®

Material 1.4435 (316L) or 1.4404 (316L)

Guide tube length Max. 6,000 mm

Pressure 10 bar

Temperature -40 ... +250 °C

Density $\geq 770 \text{ kg/m}^3$

Data sheet LM 20.01



FLM-TAI

High-temperature version, intrinsically safe

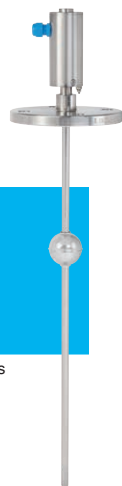

Process connection ■ Mounting thread downwards
- G 1/2" ... G 2"
- NPT 1/2" ... NPT 2"
■ Mounting flange
- ANSI 1/2" ... 2 1/2", class 150 ... 600
- EN DN 20 ... DN 65, PN 6 ... PN 100
- DIN DN 20 ... DN 65, PN 6 ... PN 100

Guide tube length 100 ... 3,000 mm (Ø 12 mm guide tube)

Pressure Vacuum to 40 bar

Temperature -40 ... +450 °C

Density $\geq 400 \text{ kg/m}^3$

Output signal 4 ... 20 mA, HART® v6

Ingress protection IP68 per IEC/EN 60529

Data sheet LM 20.01



FLM-TBD

High-temperature version with LC display, intrinsically safe or flameproof enclosure



Process connection ■ Mounting thread downwards
- G 1/2" ... G 2"
- NPT 1/2" ... NPT 2"
■ Mounting flange
- ANSI 1/2" ... 2 1/2", class 150 ... 600
- EN DN 20 ... DN 65, PN 6 ... PN 100
- DIN DN 20 ... DN 65, PN 6 ... PN 100

Guide tube length ■ 100 ... 3,000 mm (Ø 12 mm guide tube)
■ 100 ... 6,000 mm (Ø 12 mm guide tube)

Pressure Vacuum to 120 bar

Temperature -200 ... +450 °C

Density $\geq 400 \text{ kg/m}^3$

Output signal 4 ... 20 mA, HART® v6

Ingress protection IP68 per IEC/EN 60529

Data sheet LM 20.10

Continuous measurement with float for the process industry

With reed measuring chain

Applications

- Level detection for almost all liquid media
- Chemical industry, petrochemical industry, natural gas, offshore, shipbuilding, machine building, power generating equipment, power plants
- Process water and drinking water treatment, food and beverage industry, pharmaceutical industry

Special features

- Process- and procedure-specific solutions possible
- Operating limits:
 - Operating temperature: $T = -80 \dots +200 \text{ }^\circ\text{C}$
 - Operating pressure: $P = \text{vacuum to } 80 \text{ bar}$
 - Limit density: $\rho \geq 400 \text{ kg/m}^3$
- Wide variety of different electrical connections, process connections and materials
- Optionally with programmable and configurable head-mounted transmitter for 4 ... 20 mA field signals, HART®, PROFIBUS® PA and FOUNDATION™ Fieldbus
- Explosion-protected versions



FLR-SA, FLR-SB

Stainless steel version



Process connection	<ul style="list-style-type: none"> ■ Mounting thread ■ Flange DIN, ANSI, EN
Guide tube length	Max. 6,000 mm
Pressure	0 ... 100 bar
Temperature	-80 ... +200 °C
Density	$\geq 400 \text{ kg/m}^3$
Ingress protection	To IP66/IP68 per IEC/EN 60529
Data sheet	LM 20.02

FLR-SAI, FLR-SBI

Intrinsically safe



Process connection	<ul style="list-style-type: none"> ■ Mounting thread ■ Flange DIN, ANSI, EN
Guide tube length	Max. 6,000 mm
Pressure	0 ... 100 bar
Temperature	-80 ... +200 °C
Density	$\geq 400 \text{ kg/m}^3$
Ingress protection	To IP66/IP68 per IEC/EN 60529
Data sheet	LM 20.02

FLR-F

Reed level transmitter for food applications



Process connection	<ul style="list-style-type: none"> ■ Threaded pipe connection DIN 11851, downwards, DN 50 ... DN 150 ■ Clamp pipe connection DIN 32676, DN 25 ... DN 100 or 1" ... 4" ■ Clamp pipe connection ISO 2852, DN 25 ... DN 150 ■ Others on request
Guide tube length	<ul style="list-style-type: none"> ■ Max. 1,500 mm (guide tube diameter 12 mm) ■ Max. 3,500 mm (guide tube diameter 14 mm) ■ Max. 6,000 mm (guide tube diameter 18 mm)
Pressure	0 ... 25 bar
Temperature	<ul style="list-style-type: none"> ■ Normal temperature: -20 ... +120 °C ■ High temperature: +120 ... +200 °C ■ Low temperature: -80 ... -20 °C
Density	$\geq 400 \text{ kg/m}^3$
Ingress protection	To IP66/IP68 per IEC/EN 60529
Data sheet	LM 20.06

FLR-PA, FLR-PB

Plastic version, PP, PVDF, PP

Process connection ■ Mounting thread
 ■ Flange DIN,
 ANSI, EN

Guide tube length Max. 5,000 mm

Pressure 0 ... 3 bar

Temperature -10 ... +100 °C

Density $\geq 800 \text{ kg/m}^3$

Data sheet LM 20.02

**FLR-HA3**

Hygienic version, for sanitary applications

Process connection ■ Clamp ISO 2852
 ■ Clamp DIN 32767
 ■ Aseptic thread DIN 11864-1
 ■ Aseptic liner DIN 11864-1
 ■ Aseptic flange DIN 11864-2
 ■ Aseptic clamp DIN 11864-3
 ■ VARIVENT®
 ■ BioConnect®

Material 1.4435 (316L) or 1.4404 (316L)

Guide tube length Max. 6,000 mm

Pressure 10 bar

Temperature -40 ... +250 °C

Density $\geq 770 \text{ kg/m}^3$

Ingress protection To IP66/IP68 per IEC/EN 60529

Data sheet LM 20.02



Float switches for industrial applications

Applications

- Level measurement of liquids in machine building
- Control and monitoring tasks for hydraulic power packs, compressors and cooling systems

Special features

- Media compatibility: Oil, water, diesel, refrigerants and other liquids
- Permissible medium temperature range: -30 ... +150 °C
- Up to 4 switching outputs freely definable as normally open, normally closed or change-over contact
- Optional temperature output signal, selectable as preconfigured bimetal switch or either Pt100 or Pt1000



RLS-1000 Stainless steel version

Switching output	Up to 4 (normally closed, normally open, change-over contact)
Medium temperature	-30 ... +80 °C (-30 ... +150 °C optional)
Guide tube length	60 ... 1,500 mm
Data sheet	LM 50.03

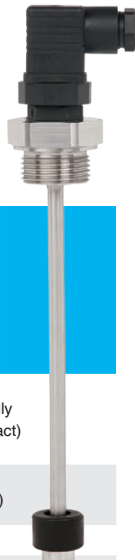

RLS-2000 Plastic version

Switching output	Up to 4 (normally closed, normally open, change-over contact)
Medium temperature	-10 ... +80 °C (-30 ... +120 °C optional)
Guide tube length	70 ... 1,500 mm
Data sheet	LM 50.04



RLS-3000 Stainless steel version, with temperature output signal

Switching output	Up to 3 (normally closed, normally open, change-over contact)
Temperature output	Normally closed, normally open, Pt100, Pt1000
Medium temperature	-30 ... +80 °C (-30 ... +150 °C optional)
Guide tube length	60 ... 1,500 mm
Data sheet	LM 50.06





RLS-4000
Intrinsic safety Ex i

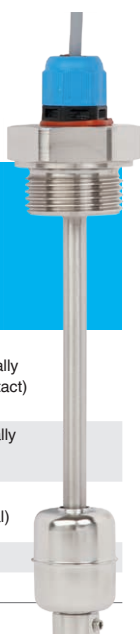

Switching output	Up to 4 (normally closed, normally open, change-over contact)
Temperature output (optional)	Normally closed, normally open, Pt100, Pt1000
Medium temperature	-30 ... +80 °C (-30 ... +150 °C optional)
Guide tube length	60 ... 1,500 mm
Data sheet	LM 50.07



RLS-5000
For the shipbuilding industry
(bilge water tanks)



Switching output	Normally closed, normally open, change-over contact
Medium temperature	-40 ... +80 °C
Electrical output	Marine cable, IP68
Test device	Optional
Data sheet	LM 50.08

RLS-6000
For water and wastewater



Switching output	Normally closed, normally open, change-over contact
Density	≥ 1,000 kg/m ³
Medium temperature	-10 ... +60 °C
Guide tube length	150 ... 1,000 mm
Data sheet	LM 50.09

RLS-7000
Miniature design,
vertical installation



Switching output	Normally closed, normally open, change-over contact
Medium temperature	-25 ... +80 °C (-25 ... 100 °C optional)
Wetted material:	<ul style="list-style-type: none"> ■ Polypropylene (PP) ■ Polyamide PA6.6 ■ Polyamide PA12 (on request)
Data sheet	LM 50.11

RLS-8000
Miniature design,
horizontal installation



Switching output	Normally closed, normally open, change-over contact
Medium temperature	-25 ... +80 °C (-25 ... 100 °C optional)
Wetted material:	<ul style="list-style-type: none"> ■ Polypropylene (PP) ■ Polyamide PA6.6 ■ Polyamide PA12 (on request)
Data sheet	LM 50.12

Float switches for the process industry

Robust switches for liquid media

Applications

- Level detection for almost all liquid media
- Pump and level control and monitoring of distinct filling levels
- Chemical industry, petrochemical industry, natural gas, offshore, shipbuilding, machine building, power generating equipment, power plants
- Process water and drinking water treatment, food and beverage industry

Special features

- Large range of application due to the simple, proven functional principle
- For harsh operating conditions, long service life
- Operating limits:
 - Operating temperature: $T = -50 \dots +350 \text{ }^\circ\text{C}$
 - Operating pressure: $P = \text{vacuum to } 40 \text{ bar}$
 - Limit density: $\rho \geq 300 \text{ kg/m}^3$
- Wide variety of different electrical connections, process connections and materials
- Explosion-protected versions



FLS-SA, FLS-SB

Stainless steel version,
for vertical installation



Switch points	Max. 8 switch points
Process connection	<ul style="list-style-type: none"> ■ Mounting thread ■ Flange DIN, ANSI, EN
Guide tube length	Max. 6,000 mm
Pressure	0 ... 40 bar
Temperature	-50 ... +300 °C
Density	$\geq 390 \text{ kg/m}^3$
Data sheet	LM 30.01

FLS-PA, FLS-PB

Plastic version,
for vertical installation



Switch points	Max. 8 switch points
Process connection	<ul style="list-style-type: none"> ■ Mounting thread ■ Flange DIN, ANSI, EN
Guide tube length	Max. 5,000 mm
Pressure	0 ... 3 bar
Temperature	-10 ... +100 °C
Density	$\geq 400 \text{ kg/m}^3$
Data sheet	LM 30.01

ELS-SFor lateral mounting
with external chamber

External chamber	Stainless steel
Process connection	Threaded pipe connection GE10-LR galvanised steel
Pressure	To 6 bar
Temperature	-30 ... +300 °C
Data sheet	LM 30.03

ELS-AFor lateral mounting
with external chamber

External chamber	Aluminium
Process connection	Threaded pipe connection GE10-LR galvanised steel
Pressure	Max. 1 bar
Temperature	-30 ... +150 °C
Data sheet	LM 30.03

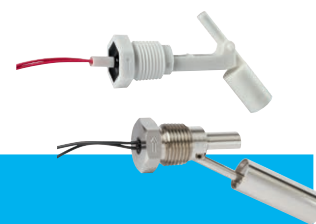
**HLS-M1,
HLS-M2**Plastic or stainless steel version, with
cable outlet

Process connection	<ul style="list-style-type: none"> ■ ½" NPT (installation in the tank from outside) ■ G ¼" (installation from inside, PP version) ■ G ½" (installation from inside, stainless steel version)
Pressure	<ul style="list-style-type: none"> ■ HLS-M1: 1 bar ■ HLS-M2: 5 bar
Temperature	<ul style="list-style-type: none"> ■ HLS-M1: -10 ... +80 °C ■ HLS-M2: -40 ... +120 °C
Material	<ul style="list-style-type: none"> ■ HLS-M1: PP ■ HLS-M2: Stainless steel 1.4301
Electrical connection	<ul style="list-style-type: none"> ■ HLS-M1: Cable ■ HLS-M2: Cable or connector
Data sheet	LM 30.06

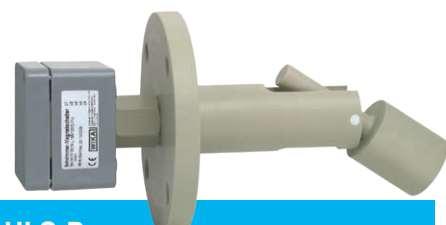
**HLS-P**

Plastic version, for horizontal installation

Process connection	Flange DIN, ANSI, EN
Pressure	0 ... 3 bar
Temperature	-10 ... +80 °C
Density	≥ 750 kg/m ³
Material	PP
Data sheet	LM 30.02

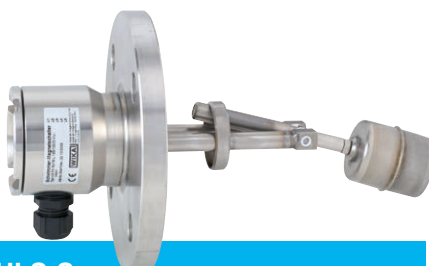
**HLS-S**Stainless steel version,
for horizontal installation

Process connection	Flange DIN, ANSI, EN
Pressure	0 ... 232 bar
Temperature	-196 ... +350 °C
Density	≥ 600 kg/m ³
Material	Stainless steel, titanium
Data sheet	LM 30.02

**HLS-SBI
Ex i**Intrinsically safe stainless steel version
for horizontal installation

Process connection	<ul style="list-style-type: none"> ■ Mounting flange: DIN DN 50 ... 100, PN 6 ... 160 EN 1092 DN 50 ... 100, PN 6 ... 160 ANSI 2" ... 4", class 150 ... 900 ■ Square flange: DN 80 and DN 92 (other flanges on request)
Pressure	0 ... 100 bar (180 bar on request)
Temperature class	T2 T3 T4 T5 T6
Process temperature	180 °C 160 °C 108 °C 80 °C 65 °C
Ambient temperature at case	80 °C
Density	600 kg/m ³
Material	Stainless steel 1.4571
Data sheet	LM 30.02

Optoelectronic switches for the process industry

Applications

- Chemical industry, petrochemical industry, natural gas, offshore
- Shipbuilding, machine building, refrigerator units
- Power generating equipment, power plants
- Process water and drinking water treatment
- Wastewater and environmental engineering

Special features

- Temperature ranges from -269 ... +400 °C
- Versions for pressure ranges from vacuum to 500 bar
- Special versions: High pressure, interface measurement
- Signal processing is made using a separate model OSA-S switching amplifier



OLS-S, OLS-H

Standard and high-pressure version

Material Stainless steel, Hastelloy, KM-glass, quartz glass, sapphire, graphite

Process connection ■ G 1/2 A
■ 1/2 NPT

Pressure 0 ... 500 bar

Temperature -269 ... +400 °C

Data sheet LM 31.01



OSA-S

Switching amplifier, for models OLS-S, OLS-H

Output 1 signal relay, 1 failure relay

Function High or low alarm

Time delay To 8 s

Voltage supply AC 24/115/120/230 V
DC 24 V

Data sheet LM 31.01



OLS-C20

Compact design, high-pressure version

Material Stainless steel, quartz glass

Process connection ■ M16 x 1.5
■ G 1/2 A
■ 1/2 NPT

Insertion length 24 mm

Pressure 0 ... 50 bar

Temperature -30 ... +135 °C

Data sheet LM 31.02



OLS-2AI

Standard and high-pressure application, intrinsically safe version (Ex i)

Measuring length 25 ... 960 mm

Pressure 0 ... 500 bar

Process temperature -269 ... +400 °C

Material Stainless steel, Hastelloy, KM-glass, quartz glass, sapphire, graphite

Process connection ■ G 1/2 A
■ 1/2 NPT
■ Flange DN 20 ... DN 50 per DIN EN 1092-1
■ Flange 1/2" ... 2" per ASME B16.5

Data sheet LM 31.07



OSA-SCI

Switching amplifier for OLS-2AI, intrinsically safe version (Ex i)

Output 1 x change-over contact (SPDT)

Auxiliary power DC 12 ... 30 V, protected against reverse polarity

Ambient temperature -20 ... +60 °C

Max. cable length 175 ... 600 m (at 0.5 ... 1.5 mm²)

Dimensions 29 x 130 x 127 mm

Mounting On 35-mm DIN rail per EN 60715:2015

Functions ■ Alarm direction selectable for high or low alarm
■ Pick-up delay and drop-out delay for signal relays adjustable to up to 8 seconds

Data sheet LM 31.07

Optoelectronic switches for industrial applications

Applications

- Limit detection of liquids
- Machine tools
- Hydraulics
- Machine building
- Water technology

Special features

- For liquids such as oils, water, distilled water, aqueous media
- Compact design
- Mounting position as required
- Accuracy ± 2 mm
- No moving components

OLS-C01 Standard version

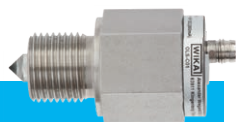

Material	Stainless steel, borosilicate glass
Process connection	G 3/8", G 1/2" or M12 x 1
Pressure	Max. 25 bar
Temperature	-30 ... +100 °C
Switching output	1 x PNP
Data sheet	LM 31.31

OLS-C02 With selectable switch length



Material	Stainless steel, borosilicate glass
Process connection	G 1/2"
Pressure	Max. 25 bar
Temperature	-30 ... +100 °C
Switch length	65 ... 1,500 mm
Switching output	1 x PNP
Data sheet	LM 31.32

OLS-C05 High-temperature version



Material	Stainless steel, borosilicate glass
Process connection	G 1/2"
Pressure	Max. 25 bar
Temperature	-40 ... +170 °C
Switching output	1 x PNP
Data sheet	LM 31.33

Optoelectronic switches for industrial applications

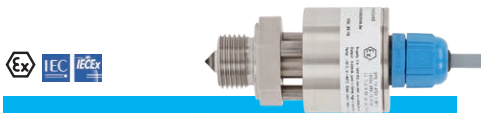

OLS-C51 Intrinsic safety Ex i

Material	Stainless steel, borosilicate glass
Process connection	G 1/2"
Pressure	Max. 40 bar
Temperature	-30 ... +135 °C
Output signal	4 ... 20 mA low/high as switching output
Data sheet	LM 31.04



OLS-C04 For refrigeration technology

Material	Steel, nickel-plated; melted glass
Process connection	G 1/2", 1/2" NPT
Pressure	Max. 40 bar
Temperature	-40 ... +100 °C
Switching output	1 x PNP
Data sheet	LM 31.34

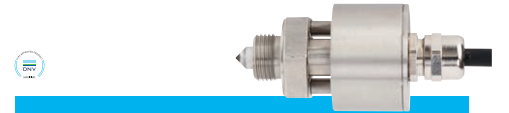

OLS-5200 For the shipbuilding industry

Material	Stainless steel, borosilicate glass
Process connection	Male thread G 1/2" or M18 x 1.5
Pressure	Max. 25 bar
Temperature	-40 ... +130 °C
Switching output	1 x PNP
Vibration resistance	10 ... 5,000 Hz, 0 ... 60g
Data sheet	LM 31.06

Vibrating level switches



TLS-S
Ex version

Material (wetted)	■ Stainless steel 1.4404 (316L)
	■ Stainless steel 1.4404, 1.4435 (316L), electropolished
	■ Stainless steel 1.4404 (316L) with PFA coating
	■ Stainless steel 1.4404 (316L) with ECTFE coating
	■ Hastelloy C-276
	■ Hastelloy C-276, electropolished

Process connection	■ G 3/4" ... 2"
	■ 3/4" ... 2" NPT
	■ DN 25 ... DN 100 per DIN EN 1092-1
	■ 1" ... 4" per ASME B16.5 / ASME BPE

Pressure -1 ... +100 bar

Temperature -40 ... +200 °C

Density $\geq 500 \dots 2,500 \text{ kg/m}^3$

Output signal

- DPDT relay output
- PNP transistor output
- NAMUR (8.2 V)

Data sheet LM 30.10



TLS-C
Compact version

Material (wetted)	■ Stainless steel 1.4404 (316L)
	■ Stainless steel 1.4404, 1.4435 (316L), electropolished
	■ Hastelloy C-276
	■ Hastelloy C-276, electropolished

Process connection	■ G 3/4" ... 2"
	■ 3/4" ... 2" NPT
	■ 1" ... 4" per ASME BPE

Pressure -1 ... +64 bar

Temperature -40 ... +150 °C

Density $\geq 500 \dots 2,500 \text{ kg/m}^3$

Output signal

- SPST relay output
- PNP transistor output

Data sheet LM 30.10



TLS-H
Hygienic design version

Material (wetted)	■ Stainless steel 1.4404 (316L)
	■ Stainless steel 1.4404, 1.4435 (316L), electropolished
	■ Hastelloy C-276
	■ Hastelloy C-276, electropolished

Process connection	■ G 3/4" ... 2"
	■ 3/4" ... 2" NPT
	■ 1" ... 4" per ASME BPE

Pressure -1 ... +64 bar

Temperature -40 ... +150 °C

Density $\geq 500 \dots 2,500 \text{ kg/m}^3$

Output signal

- SPST relay output
- PNP transistor output

Data sheet LM 30.10

Compression force transducers

Compression force transducers are designed for determining compression forces and are suitable for static and dynamic measurements in the direct force flow. WIKA force transducers are manufactured from stainless steel and other high-quality materials, are robust and are notable for their reliability and high quality even in complex applications. Our compression force transducers are available in different rated loads.

They cover a wide range of application areas: For instance, these force transducers are employed in machine building or in the automation of plants to determine the pressing and joining forces, as well as for detecting weight in many industrial applications. You can select the pertinent technical and regional approvals as options.



EAC **LoRaWAN** 

F1106, F1119, F1136
Hydraulic compression force transducer, clamping force test instrument to 500 kN

Rated force F_{nom}	0 ... 160 N to 0 ... 500 kN
Relative linearity error	<ul style="list-style-type: none"> Analogue $\leq \pm 1.6\% F_{nom}$ Digital $\leq \pm 0.5\% F_{nom}$
Display	<ul style="list-style-type: none"> Analogue indication Digital display Pressure sensor
Ingress protection	IP65, digital IP67
Data sheet	FO 52.13, FO 52.10, FO 52.27



EAC 

F1102
Hydraulic compression force transducer, welding tongs test instrument to 36 kN

Rated force F_{nom}	0 ... 100 N to 0 ... 36 kN
Relative linearity error	<ul style="list-style-type: none"> Analogue $\leq \pm 1.6\% F_{nom}$ Digital $\leq \pm 0.5\% F_{nom}$
Display	<ul style="list-style-type: none"> Analogue indication Digital display Pressure sensor
Ingress protection	IP65, IP67
Data sheet	FO 52.16



EAC 

F1103, F1112, F1122
Hydraulic compression force transducer, 3-jaw clamping force test instrument to 1,000 kN

Rated force F_{nom}	0 ... 1.1 kN to 0 ... 1,000 kN
Relative linearity error	<ul style="list-style-type: none"> Analogue $\leq \pm 1.6\% F_{nom}$ Digital $\leq \pm 0.5\% F_{nom}$
Display	<ul style="list-style-type: none"> Analogue indication Digital display Pressure sensor
Ingress protection	IP65, IP67
Data sheet	FO 52.24, FO 52.25, FO 52.26



EAC 

F1201
Compression force transducer to 36 kN

Rated load F_{nom}	0 ... 5 t to 0 ... 30 t
Relative linearity error	$\leq \pm 0.05\% F_{nom}$
Output signal	2.0 \pm 0.2 mV/V
Ingress protection	IP68
Data sheet	FO 51.71



EAC

F1222
Miniature compression force transducer from 10 N

Rated force F_{nom}	0 ... 10 N to 0 ... 5,000 N
Relative linearity error	$\pm 1\% F_{nom}$
Output signal	<ul style="list-style-type: none"> ± 0.1 mV/V (10 N) ± 0.2 mV/V (20 N to 5 kN)
Ingress protection	IP65
Data sheet	FO 51.11



EAC **LoRaWAN** 

F1861
Compression force transducer with bilateral spherical force introduction to 50 t

Rated load F_{nom}	0 ... 10 t to 0 ... 50 t
Relative linearity error	$\leq 0.03\% F_{nom}$
Output signal	<ul style="list-style-type: none"> 2.0 \pm 0.2 mV/V LoRaWAN®/BLE in connection with NETRIS®F
Ingress protection	IP67
Data sheet	FO 51.61

Tension/Compression force transducers

WIKA offers tension/compression force transducers in different designs and versions. They are available in miniature designs, as traditional s-type, as transducers with different thread forms or as low-profile force transducers. Transducers in miniature design are used for small mounting spaces and also for detecting small forces. The s-type with female thread, which is very well suited for this purpose, features a particularly high accuracy and is used

in rated load ranges of up to 50 kN. For measuring high forces, tension/compression force transducers in compact design are the first choice. For low-profile force transducers, the force is transmitted via the central female thread. They are highly dynamic and possess a high fatigue strength.

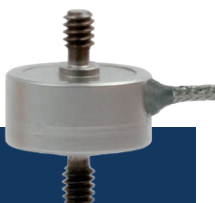

F2220, F2221
Miniature tension/compression force transducer from 10 N

Rated force F_{nom} 0 ... 10 N to 0 ... 50 kN

Relative linearity error From $\pm 0.15\%$ F_{nom}

Output signal 1.5 ± 0.15 or 2.0 ± 0.2 mV/V

Ingress protection IP65

Data sheet FO 51.16, FO 51.26



F2222
Tension/Compression force transducer up to 2,200 kN

Rated force F_{nom} 0 ... 22 N up to 0 ... 2,200 kN

Relative linearity error $\pm 0.1\%$ F_{nom}

Output signal ■ ≤ 25 lb: 2 mV/V
■ > 50 lb: 3 mV/V

Ingress protection IP66

Data sheet FO 51.29



F2226
Tension/Compression force transducer, male thread to 3,300 kN

Rated force F_{nom} 0 ... 10 kN to 0 ... 3,300 kN

Relative linearity error ■ $\leq \pm 0.15\%$ F_{nom} (≤ 200 kN)
■ $\leq \pm 0.20\%$ F_{nom} (> 200 kN)

Output signal 2 mV/V

Ingress protection IP66

Data sheet FO 51.51



F2301, F23C1, F23S1
Tension/Compression force transducer with thin-film technology to 500 kN

Rated force F_{nom} 0 ... 1 kN to 0 ... 500 kN

Relative linearity error $\pm 0.5\%$ F_{nom}

Output signal ■ 4 ... 20 mA, 2-wire/3-wire
■ 0 ... 10 V, 3-wire
■ CANopen®
■ Redundant versions available

Ingress protection IP66, IP67, IP68, IP69, IP69K

Data sheet FO 51.17



F2802
Tension/Compression force transducer, s-type to 50 kN

Rated force F_{nom} 0 ... 0.5 kN to 0 ... 50 kN

Relative linearity error ■ Steel $\pm 0.03\%$ F_{nom}
■ Stainless steel $\pm 0.05\%$ F_{nom}

Output signal ■ 2.0 $\pm 5\%$ mV/V
■ LoRaWAN®/BLE in connection with NETRIS®F

Ingress protection IP65 (< 5 kN), IP67 (≥ 5 kN)

Data sheet FO 51.48



F2808
Tension/Compression force transducer from 5 N

Rated force F_{nom} 0 ... 5 N to 0 ... 2,000 N

Relative linearity error $\pm 0.15\%$ F_{nom}

Output signal ■ 2.0 $\pm 10\%$ mV/V
■ LoRaWAN®/BLE in connection with NETRIS®F

Ingress protection IP66

Data sheet FO 51.68

Bending/Shear beams

Bending beams and shear beams are used for the determination of (shear) forces and are suitable for both static (weighing technology) and dynamic (machine building) measurement projects. To determine how strong the force is in the application, strain gauges or thin-film sensors are used, which are attached on or in the measuring body.

The application areas of the bending beam and shear beam are many and varied. Thus, these load cells are very often used in industrial weighing technology as well as in the areas of special machine building, manufacturing automation and gravimetric level measurement. In addition, they are used in the laboratory and process industry for the indirect determination of torques.



**F3201,
F3831**
Shear beam to 10 t

Rated load F_{nom}	0 ... 500 kg to 0 ... 10,000 kg
Relative linearity error	From $\pm 0.017\%$ F_{nom}
Output signal	<ul style="list-style-type: none"> ■ 2.0 ± 0.2 mV/V ■ LoRaWAN®/BLE in connection with NETRIS®F
Ingress protection	IP65, IP67, IP68, IP69K, depending on version
Data sheet	FO 51.21, FO 51.72



**F3203,
F3833**
Bending beam to 500 kg

Rated load F_{nom}	0 ... 5 kg to 0 ... 500 kg
Relative linearity error	From $\pm 0.017\%$ F_{nom}
Output signal	<ul style="list-style-type: none"> ■ 2.0 ± 0.2 mV/V ■ LoRaWAN®/BLE in connection with NETRIS®F
Ingress protection	IP68, IP69, depending on version
Data sheet	FO 51.22, FO 51.73



AZK02
Mounting kit
for shear beams F3201 and F3831

Data sheet	FO 51.21
------------	----------



AZK03
Mounting kit for bending beams
F3203 and F3833

Data sheet	FO 51.22
------------	----------



FA201
Mounting kit for compression force
transducers for rated loads to 30 t

Rated load F_{nom}	2.5 t ... 30 t
Data sheet	AC 50.13

Load cells

Load cells are designed as a special form of force transducers for use in weighing equipment. They enable very high measurement accuracies between 0.01 % and 0.05 % F_{nom} .

The single point load cell is a typical and widely used load cell geometry. In addition, there are corresponding mounting kits and complete weighing modules available.



F4801

Single point load cell
up to 250 kg

Rated load F_{nom} 0 ... 3 to 0 ... 250 kg

Relative linearity error 0.02 % F_{nom}

Output signal

- 2.0 ± 10 % mV/V
- LoRaWAN®/BLE in connection with NETRIS®F

Ingress protection IP65

Data sheet FO 53.10



F4802

Single point load cell
up to 10 kg

Rated load F_{nom} 0 ... 0.3 kg to 0 ... 10 kg

Relative linearity error 0.02 % F_{nom}

Output signal

- 1.0 ± 10 % mV/V (0.3 ... 0.5 kg)
- 2.0 ± 10 % mV/V (1 ... 10 kg)
- LoRaWAN®/BLE in connection with NETRIS®F

Ingress protection IP65

Data sheet FO 53.13



F4818

Single point load cell
up to 500 kg

Rated load F_{nom} 0 ... 20 kg to 0 ... 500 kg

Relative linearity error 0.02 % F_{nom}

Output signal

- 2.0 ± 10 % mV/V
- LoRaWAN®/BLE in connection with NETRIS®F

Ingress protection IP65

Data sheet FO 53.14



F4881

Load cell
for multihead weighers

Rated load F_{nom} 0 ... 2 kg to 0 ... 30 kg

Relative linearity error 0.02 % F_{nom}

Output signal

- 2.0 ± 0.2 mV/V
- LoRaWAN®/BLE in connection with NETRIS®F

Ingress protection IP67

Data sheet FO 53.16



F4882, F4883, F4884, F4885

Load cells for checkweighers

Rated load F_{nom} 0 ... 1 kg to 0 ... 635 kg

Relative linearity error ≤ 0.02 % F_{nom}

Output signal

- 2.0 ± 0.2 mV/V
- LoRaWAN®/BLE in connection with NETRIS®F

Ingress protection IP66 or IP67

Data sheet FO 53.17, FO 53.18, FO 53.19, FO 53.20

Load pins

Load pins represent one of the most important components for measuring forces. Existing retention bolts can easily be replaced by these products in existing applications. The application areas range from construction machinery and cranes to manufacturing automation. These force transducers are often used by designers because, due to their design, they can be directly integrated into the force flow, without taking up space.

Since the design requirements for the use of load pins are very individual, the exact layout is important. With WIKA, you will have specialists by your side who already have lots of experience in force measurement.

F5308, F53C8, F53S8



Load pin, heavy-duty version, thin-film technology from 10 kN

Rated force F_{nom}	From 10 kN
Relative linearity error	$\pm 1\% F_{nom} / \pm 1.5\% F_{nom}$
Output signal	<ul style="list-style-type: none"> ■ (2 x) 4 ... 20 mA, 2-wire/3-wire ■ (2 x) 0 ... 10 V, 3-wire ■ CANopen®
Ingress protection	<ul style="list-style-type: none"> ■ Unplugged state IP66, IP67 ■ Plugged-in state IP68, IP69, IP69K
Data sheet	FO 51.43

F5301, F53C1



Load pin with thin-film technology to 200 kN

Rated force F_{nom}	0 ... 5 kN to 0 ... 200 kN
Relative linearity error	$\pm 1\% F_{nom}$
Output signal	<ul style="list-style-type: none"> ■ (2 x) 4 ... 20 mA, 2-wire/3-wire ■ (2 x) 0 ... 10 V, 3-wire ■ CANopen®
Ingress protection	<ul style="list-style-type: none"> ■ Unplugged state IP66, IP67 ■ Plugged-in state IP68, IP69, IP69K
Data sheet	FO 51.18

F5802



Load pin from 20 kN

Rated force F_{nom}	20 ... 10,000 kN
Relative linearity error	$0.5\% \dots 1\% F_{nom}$
Output signal	<ul style="list-style-type: none"> ■ (2 x) 4 ... 20 mA, 2-wire/3-wire ■ (2 x) 0 ... 10 V, 3-wire ■ CANopen®
Ingress protection	<ul style="list-style-type: none"> ■ Unplugged state IP66, IP67 ■ Plugged-in state IP68, IP69, IP69K
Data sheet	FO 51.55

Tension links

Large lifting equipment and cranes generally move high to very high loads. In (container) ports, in offshore applications or on construction sites, (failure) safety in the movement of goods and loads is important. Man and machine must be protected equally and a smooth process must be ensured. Among other things, when moving loads, tension links, which are placed directly in the force flow, ensure safe operation in order to prevent overloading of the machinery. These force transducers are available in very small dimensions up to very large formats. Tension links from WIKA with proven thin-film technology guarantee maximum safety in their application thanks to their first-rate quality.

F7301, F73C1, F73S1



Tension link with thin-film technology from 5 kN

Rated force F_{nom}	From 0 ... 5 kN
Relative linearity error	$\pm 0.5\% F_{nom}$
Output signal	<ul style="list-style-type: none"> ■ (2 x) 4 ... 20 mA, 2-wire/3-wire ■ (2 x) 0 ... 10 V, 3-wire ■ CANopen®
Ingress protection	<ul style="list-style-type: none"> ■ Unplugged state IP66, IP67 ■ Plugged-in state IP68, IP69, IP69K
Data sheet	FO 51.19

Ring force transducers

These force transducers are extremely robust and are suitable for the detection of very high (static) forces. Furthermore, they are suitable for many installation situations. The ring geometry is used in force measurement for a wide variety of spatial conditions. The main fields of application are found in spindle presses, in screw force measurement or even in geotechnology.

WIKA offers electrical and hydraulic ring force transducers in diameters from 12 millimetres up to 430 millimetres as well as in various installation heights.

Discover our portfolio now.

ERC

F6212



Ring force transducer
to 100 kN

Rated force F_{nom} 0 ... 2 to 0 ... 100 kN

Relative linearity error $\leq 0.5\% F_{nom}$

Output signal 0.8 ... 1.2 ± 0.1 mV/V

Ingress protection IP65

Data sheet FO 51.27

ERC

F6215

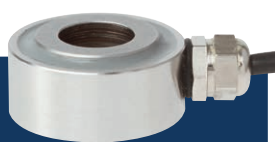

Ring force transducer
to 1,500 kN

Rated force F_{nom} 0 ... 15 to 0 ... 1,500 kN

Relative linearity error $\leq \pm 1\% F_{nom}$

Output signal 0.8 ... 1.2 ± 0.1 mV/V

Ingress protection IP65

Data sheet FO 51.28

ERC LoRaWAN



F6804

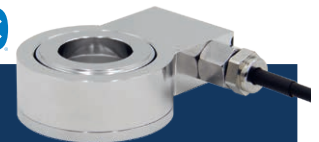

Ring force transducer
to 450 kN

Rated force F_{nom} 0 ... 3 kN to 0 ... 450 kN

Relative linearity error $2\% F_{nom}$

Output signal 1.0 ± 0.1 mV/V

Ingress protection IP65

Data sheet FO 51.60

ERC LoRaWAN



F6116



Hydraulic ring force transducer to 120 kN

Rated force F_{nom} 0 ... 320 N to 0 ... 120 kN

Relative linearity error \blacksquare Analogue $\leq \pm 1.6\% F_{nom}$
 \blacksquare Digital $\leq \pm 0.5\% F_{nom}$

Display \blacksquare Analogue indication
 \blacksquare Digital display
 \blacksquare Pressure sensor

Ingress protection IP65, IP67

Data sheet FO 52.18

ERC LoRaWAN



F6154



Hydraulic ring force transducer,
heavy-duty version to 1,500 kN

Rated force F_{nom} 0 ... 25 kN to 0 ... 1,500 kN

Relative linearity error \blacksquare Analogue $\leq \pm 1.0\% F_{nom}$
 \blacksquare Digital $\leq \pm 0.5\% F_{nom}$

Display \blacksquare Analogue indication
 \blacksquare Digital display
 \blacksquare Pressure sensor

Ingress protection IP65, IP67

Data sheet FO 52.17

Special force transducers

We refer to force transducers that do not fit into any standard design as special force transducers. Due to the specification of the requirement, in some cases design-engineered solutions must be considered. As a long-standing manufacturer of force measurement technology, WIKA brings this expertise into play and can find the best and, at the same time, most cost-effective solution for the customer.

Among our special force transducers are, for example, strain transducers that enable components to measure or force transducers for checking rope tension (wire rope force transducers). The applications in which special force transducers are used are wide-ranging and always require great experience in their engineering. You can count on this when you trust in the right solution from WIKA.



F9204
Wire rope force transducer to 40 t

Rated load F_{nom}	0 ... 1 to 0 ... 40 t
Relative linearity error	$\pm 3\% F_{nom}$
Output signal	4 ... 20 mA, 2-wire
Ingress protection	IP66
Data sheet	FO 51.25



F9302
Strain transducer to 1,000 $\mu\epsilon$

Strain F_{nom}	0 ... ± 200 , 0 ... ± 500 , 0 ... $\pm 1,000 \mu\epsilon$
Relative linearity error	$\leq \pm 2\% F_{nom}$
Output signal	4 ... 20 mA, 3-wire
Ingress protection	IP67
Data sheet	FO 54.10

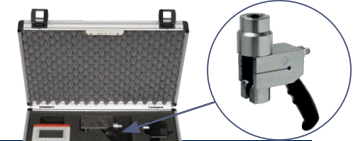

FRKPS
Chain hoist test set for checking friction clutches

Rated force F_{nom}	40 ... 3,500 kg
Relative linearity error	0.5 % F_{nom}
Output signal	4 ... 20 mA
Ingress protection	■ Force transducer IP67 ■ Display instrument IP40
Data sheet	FO 51.69

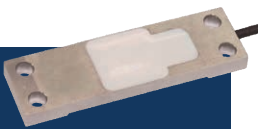

F9846
Strain transducer to 1,000 $\mu\epsilon$

Nominal strain F_{nom}	0 ... 200 $\mu\epsilon$ to max. 0 ... 1,000 $\mu\epsilon$
Relative linearity error	$\pm 1\% F_{nom}$
Output signal	■ 1.0 ± 0.1 mV/V ■ LoRaWAN®/BLE in connection with NETRIS®F
Ingress protection	IP65
Data sheet	FO 54.17

Electronics

Many force measurement applications can be complemented by electronic components. To ensure that all system-relevant components come from a single source, WIKA continuously expands its product range with useful electronics. WIKA offers controllers, amplifiers, limit switches, digital displays, weighing indicators and electronic accessories that ensure trouble-free

operation. With the help of electronics matched to the measuring components, set limit values are maintained and checked with the reading instruments. Amplifiers are available with analogue and digital output signals. The LED or LC displays are available with 4 or 6 digits.



B1940

Analogue cable amplifier for strain gauge measuring bridges

Input Strain gauge measuring bridge, 4- or 6-wire

Output 0/4 ... 20 mA, DC 0 ... 10 V

Special feature

- High accuracy
- Cable length between amplifier and evaluation unit to 100 m are possible
- Compact design
- Ingress protection IP67

Auxiliary power DC 12 ... 28 V

Data sheet AC 50.09



ELMS1

Safety electronics PLe in accordance with DIN EN ISO 13849-1

Input

- 8 safe 4 ... 20 mA analogue inputs
- 8 safe digital inputs
- Fieldbus

Output

- 2 safe relay outputs
- 6 safe, positive-switching solid-state outputs
- Fieldbus

Special feature

- Certified safety electronics, certified in accordance with DIN EN ISO 13849-1, PLe
- Certified system solution incl. force measurement, certified in accordance with DIN EN 13849-1 cat. 3, PLd

Auxiliary power DC 24 V

Data sheet AC 50.06



EGS80

Digital limit switch

Input

- 0/4 ... 20 mA

Output

- Two potential-free relay contacts (change-over) with status LED
- One freely programmable analogue output (0 ... 20 mA)

Special feature

- Galvanic isolation, line break (LB) and short-circuit (SC) monitoring to SIL 2 per IEC 61508

Auxiliary power

- DC 20 ... 90 V
- AC 48 ... 253 V

Data sheet AC 50.01



E1930, E1931, E1932

Multi-function display for industrial and analogue measuring instruments

5/6-digit digital indicator with high accuracy

Ingress protection IP65

Data sheet FO 58.05, FO 58.06, FO 58.07



FE430-A1

Universal weighing indicator

Input mV/V, terminal connection, 4- or 6-wire

Output RS-232-C

Special feature

- LC display with 25 mm character size, adjustable weight-dependent colour change (e.g. green - yellow - red)
- Simple weighing, piece counting, smart animal weighing or checkweighing
- Zero, tare, multiple taring, auto-taring and unit change
- Dimensions 134 x 224 x 74 mm
- Ingress protection IP65

Auxiliary power

- DC 12 V
- AC 110 ... 230 V

Data sheet FO 58.08



B6578

Junction box for load cells

Number of load cells Max. 4

Ingress protection IP67

Data sheet FO 58.02



Orifice plates and assemblies

Orifice plates represent the most common primary flow elements in the world due to their proven technology and ease of installation and maintenance.

Main characteristics

- Maximum operating temperature to 800 °C
- Maximum operating pressure to 400 bar
- Suitable for liquid, gas and steam flow measurement
- Accuracy: Uncalibrated $\pm 0.5 \dots 2.5 \%$
- Repeatability of measurement 0.1 %

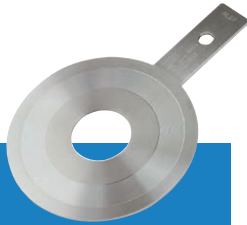

FLC-OP
Orifice plate

Standards ■ ISO 5167-2
■ ASME MFC3M

Pipe size ■ $\geq 2"$
■ ≥ 50 mm

β Depending on version

Accuracy ¹⁾ Uncalibrated $\pm 0.5 \dots 2.5 \%$

Data sheet FL 10.01

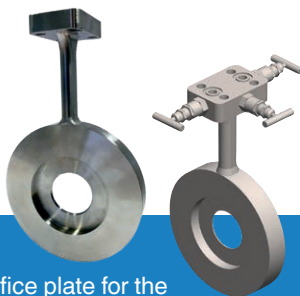

FLC-CO
Compact orifice plate for the direct mounting of differential pressure transmitters

Standards ■ ISO 5167-2
■ ANSI/ASME B16.5

Pipe size ■ 2 ... 14"
■ DN 50 ... 350

β Depending on version

Accuracy $\leq \pm 0.5 \%$

Data sheet FL 10.10

Versions

■ Square edge orifice plates (standard version)

This design is intended for general applications in clean liquids and gases.

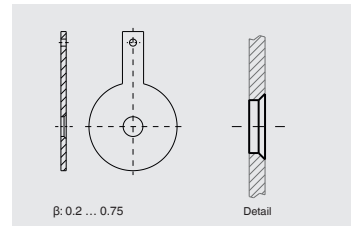

■ Quarter circle and conical entrance orifice plates

The best choice for measurement of liquids with low Reynolds number.

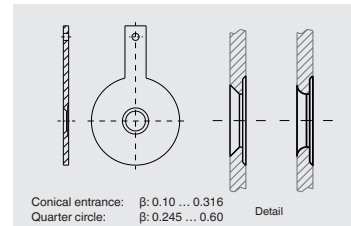

■ Segmental orifice plates

For measurements with two-phase, dirty and solids-containing media.

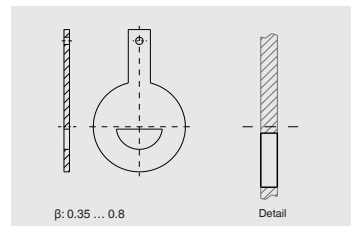

■ Eccentric orifice plates

The application areas are similar to the segmental version. However, an eccentric orifice plate is the better solution for smaller pipe diameters.

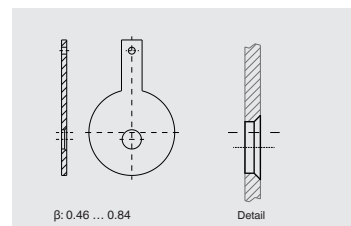

Orifice flanges are intended for use instead of standard pipe flanges when an orifice plate or flow nozzle must be installed. Pairs of pressure tapings are machined into the orifice flange, making separate orifice carriers or tapings in the pipe wall unnecessary.

Main characteristics

- Wide range of materials available
- The number and type of pressure tapping (flange tap or corner tap) can be manufactured to customer requirements
- Special assemblies can be designed on request



FLC-FL Orifice flange

Standards

- ISO 5167-2
- ASME B16.36

Pipe size

- $\geq 2"$
- ≥ 50 mm

β Depending on version

Accuracy ¹⁾ Uncalibrated $\pm 0.5 \dots 2.5$ %

Data sheet FL 10.12



FLC-MP Multi-hole orifice plate

Standards

- ISO 5167-2
- AGA Report number 3
- ASME B16.36

Pipe size

- 50 ... 600 mm [2" ... 24"]
- Larger versions on request

β 0.2 ... 0.65

Accuracy ¹⁾ 1 ... 2 % depending on beta ratio and Reynolds number

Data sheet FL 10.15

Annular chambers are designed to be mounted between standard pipe flanges. Versions are available to suit all common flange standards, including DIN and ANSI B16.5.

Main characteristics

- Standard material is 316/316L stainless steel, but a wide range of alternative materials is available
- Seals are included in the scope of delivery (as standard, 4.4 mm thick spiral-wound sealing 316/graphite filler, unless requested otherwise)



FLC-AC Annular chamber

Standards ISO 5167-2

Pipe size

- $\geq 2"$
- ≥ 50 mm

β Depending on version

Accuracy ¹⁾ Uncalibrated $\pm 0.5 \dots 2.5$ %

Data sheet FL 10.13

Meter runs

To ensure high accuracy in the flow measurement of liquids, gases and steam the primary flow element is supplied as an assembly incorporating the upstream and downstream pipe sections required by ISO 5167-1:2003. This assembly is known as a "meter run".

Main characteristics

- Nominal width < 1 1/2"
- Nominal pressure rating 300 ... 2,500 depending on model/version
- Wide range of materials available

A calibration of the instrument can be performed if higher accuracy is required.

An integral orifice plate is normally selected when the pipe diameter is 1 1/2" or smaller and the medium is clean. An extremely compact installation can be ensured as the pressure sensor can be mounted directly onto the meter run. Without a calibration, an accuracy of ±1 ... 2 % can be expected, the actual values will be confirmed during the engineering phase.

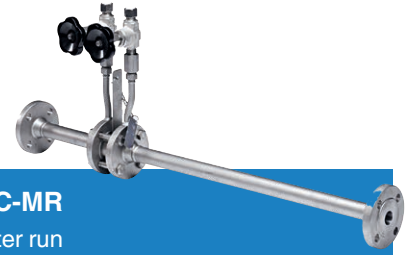

FLC-MR
Meter run

Standards	ISO 5167-2
Pipe size	<ul style="list-style-type: none"> ■ 1/2 ... 1 1/2 in ■ 12 ... 40 mm
β	0.2 ... 0.75
Accuracy	Uncalibrated ±1 ... 2 %
Data sheet	FL 10.02

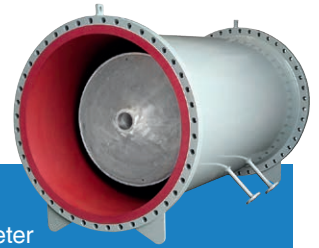

FLC-FC
Cone flow meter

Standards	ISO 5167-5
Pipe size	2 ... 64"
β and pipe length	0.45/0.6/0.75
Special feature	Low requirements for straight upstream and downstream pipes
Data sheet	FL 10.11

Special assemblies



FLC-HHR-PP

HHR ProPak™ flow meter
for oil and gas

Pipe size	2", 3", 4", 6" or 8"
β and pipe length	0.75 or 0.40
Special feature	No need for straight upstream and downstream pipes
Data sheet	FL 10.07



FLC-HHR-FP

HHR FlowPak® flow meter

Pipe size	3 ... 48"
β and pipe length	0.40 ... 0.70
Special feature	No need for straight upstream and downstream pipes
Data sheet	FL 10.09



FLC-WG

Wedge flow meter for slurries and highly viscous media

Standards	ISO 5167-6
Pipe size	1 ... 24"
H/D ratios	0.2/0.3/0.4/0.5
Special feature	<ul style="list-style-type: none"> ■ Low maintenance through robust design ■ For very high and very low Reynolds numbers ■ Bidirectional measurement possible
Data sheet	FL 10.08

Flow nozzles

A flow nozzle consists of a convergent section with a rounded profile and a cylindrical throat. This design is generally selected for steam flow measurement at high velocity.

To reduce pressure loss an axisymmetric solution, called a Venturi nozzle, can be offered. It combines the standard features of a flow nozzle with a divergent section.

Main characteristics

- Suitable for liquid, gas and steam flow measurement
- Optimum solution for measuring the flow of steam
- Accuracy: Uncalibrated $\pm 0.8 \dots 2 \%$
- Repeatability of measurement 0.1 %
- Lower pressure loss compared to orifice plate family

Flow nozzle for in-pipe installation

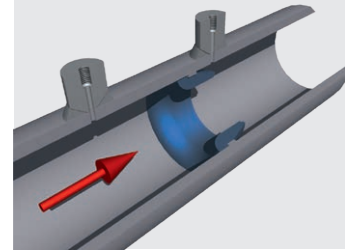

Venturi nozzle

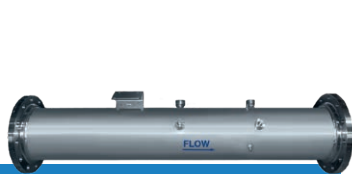
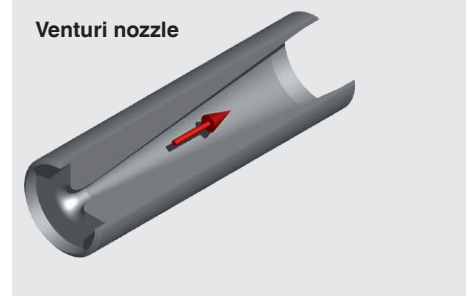

FLC-FN-PIP

Flow nozzle for in-pipe installation

Pipe size ■ ≥ 2 in
■ ≥ 50 mm

β 0.2 ... 0.8

Accuracy ¹⁾ Uncalibrated $\leq \pm 1 \%$

Data sheet FL 10.03



FLC-FN-FLN

Flow nozzle for flange assembly

Pipe size ■ ≥ 2 in
■ ≥ 50 mm

β 0.3 ... 0.8

Accuracy ¹⁾ Uncalibrated $\pm 0.8 \%$

Data sheet FL 10.03



FLC-VN

Venturi nozzle

Pipe size ■ ≥ 2 in
■ ≥ 50 mm

β 0.316 ... 0.775

Accuracy ¹⁾ Uncalibrated $\pm 1 \%$

Data sheet FL 10.03

Venturi tubes

A Venturi tube is a reliable and easily managed and maintained instrument that can measure a wide range of clean liquids and gases.

The main advantage of a Venturi tube over other differential pressure flow measuring instruments is the higher pressure recovery and the lower upstream and downstream straight tube length requirements.

Main characteristics

- In accordance with ISO 5167-4 and ASME MFC-3M standards
- Fabricated from plate or machined from bar/forgings
- Flanged or weld-in construction
- Wide range of materials available
- Pipe sizes from 50 ... 1,200 mm
- Wide variety of pressure tapings available
- Calibration possible on request
- Accuracy: Uncalibrated $\pm 0.5 \dots 1.5 \%$

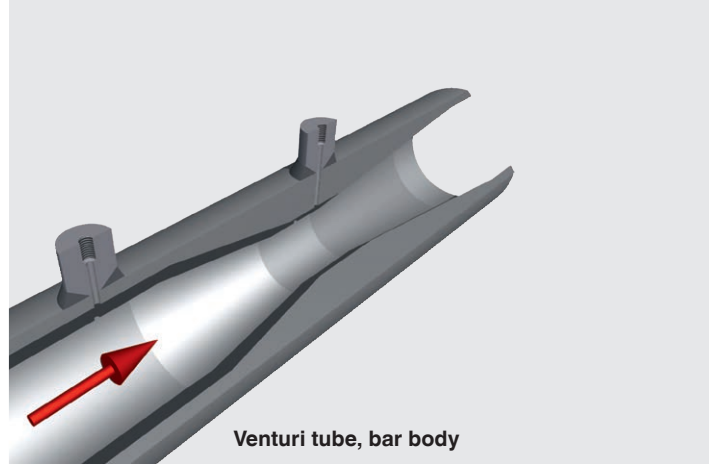

FLC-VT-BAR
Venturi tube, bar body

Pipe size	<ul style="list-style-type: none"> ■ 2 ... 10 in ■ 50 ... 250 mm
β	0.4 ... 0.75
Accuracy ¹⁾	Uncalibrated $\leq \pm 0.5 \%$
Data sheet	FL 10.04



FLC-VT-WS
Venturi tube, welded sheet

Pipe size	<ul style="list-style-type: none"> ■ ≥ 14 in ■ 200 ... 1,200 mm
β	0.4 ... 0.7
Accuracy ¹⁾	Uncalibrated $\pm 1.5 \%$
Data sheet	FL 10.04

FloTec (averaging pitot tubes)

FloTec (a multi-port, averaging pitot tube) measures the difference between the static pressure and the dynamic pressure of the media in the pipe. The volumetric flow is calculated from that difference using Bernoulli's principle and taking into account the pipe inner diameter. Using four dynamic ports this instrument is able to evaluate a better velocity profile inside the pipe. This ensures a higher accuracy in the flow measurement.

Main characteristics

- Low installation costs
- Long-term accuracy
- Minimal permanent pressure loss
- Fixed and extractable versions available

Vortex shedding frequency

Depending on the inner diameter, the medium characteristics and the Reynolds number, a vortex will be generated around the pitot tube. A support mounted on the opposite side of the pipe can be supplied should the natural frequency of the pitot coincide with the vortex shedding frequency. The necessity test is performed during the design phase.

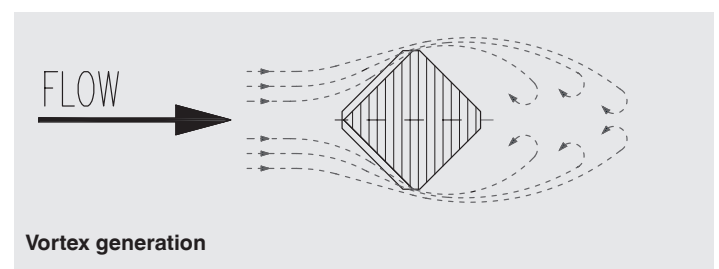

FLC-APT-E FloTec, extractable

Pipe size ■ ≥ 3 in
■ $\geq 50 \dots 1,800$ mm

Accuracy Uncalibrated ± 1 %

Data sheet FL 10.05



FLC-APT-F FloTec, fixed

Pipe size ■ ≥ 3 in
■ $\geq 50 \dots 1,800$ mm

Accuracy Uncalibrated ± 1 %

Data sheet FL 10.05

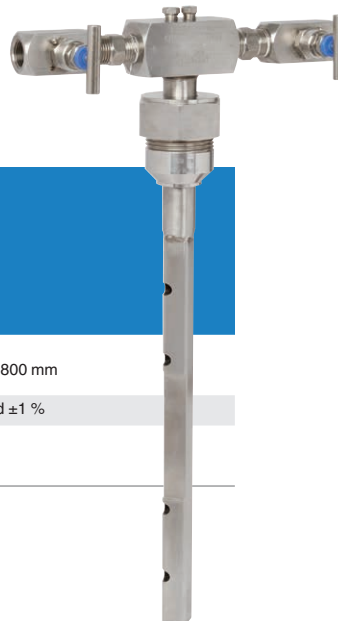

Restriction orifices

When a reduction of pressure or a limitation of the flow rate is required, a restriction orifice must be inserted into the pipeline. Our technical department will produce the correct design for the restriction orifice, depending on customer requirements and flow conditions.

If a high pressure drop is required, phase changes or sound problems can occur, so that a more complex design might be needed. The solution in these cases is to decrease the differential pressure in several steps, avoiding all the issues created by these factors. This solution is called multi-step restriction orifice.

Main characteristics

- Multi-step restriction orifices to reduce cavitation or undesired choking of the flow
- Multi-hole designs to reduce the noise level



FLC-RO-ST
Single-step restriction orifice

Nominal size	½ ... 24"
Special feature	<ul style="list-style-type: none"> ■ Suitable for liquids, gases and steam ■ Single-bore or multi-hole versions
Data sheet	FL 10.06



FLC-RO-MS
Multi-step restriction orifice

Nominal size	½ ... 24"
Special feature	<ul style="list-style-type: none"> ■ Suitable for liquids, gases and steam ■ Special design with variable sections, with extension for high pressure drop requirements in gas applications
Data sheet	FL 10.06

Ultrasonic flow meter

For custody transfer of gases

By calculating velocity ratios between two or more ultrasonic paths, the model FLC-UFL provides reliable gas flow measurement. Additional measured variables, such as speed of sound, signal-to-noise ratio or signal strength, are available for condition monitoring. For applications requiring integrated volume conversion, pressure and temperature sensors can be connected.

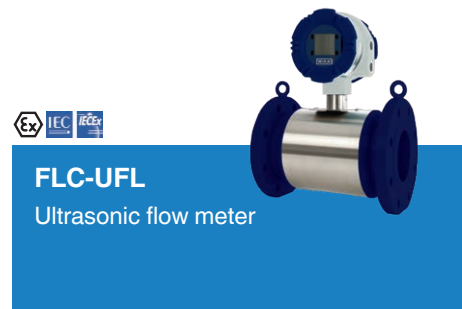

FLC-UFL
Ultrasonic flow meter

Pressure range	To 153 bar [2,250 psi]
Accuracy	<p>FLC-UFL 1:</p> <ul style="list-style-type: none"> ■ 2 % (> 3 m/s) ■ 3 % (0.1 ... 3 m/s) <p>FLC-UFL 2:</p> <ul style="list-style-type: none"> ■ 1.5 % (> 3 m/s) ■ 2 % (0.1 ... 3 m/s) <p>FLC-UFL 3:</p> <ul style="list-style-type: none"> ■ 1 % ($Q_t - Q_{max}$) ■ 2 % ($Q_{min} - Q_t$) <p>FLC-UFL 4:</p> <ul style="list-style-type: none"> ■ 0.5 % ($Q_t - Q_{max}$) ■ 1 % ($Q_{min} - Q_t$)
Data sheet	FL 40.01

Flow switches

For monitoring liquid media



FSD-4

For liquid media

Measuring range	<ul style="list-style-type: none"> Flow: 0 ... 3 m/s Temperature: -20 ... 85 °C
Output signal	<ul style="list-style-type: none"> 1 or 2 switching outputs plus optional analogue output Switching outputs PNP or NPN adjustable Analogue output 4 ... 20 mA or 0 ... 10 V adjustable Optional IO-Link
Process connection	<ul style="list-style-type: none"> G ¼ A, G ½ A ¼ NPT, ½ NPT M18 x 1.5 Various compression fittings optional

Data sheet FL 80.02



FSM-6100

For industrial heat exchangers

Measuring range	<ul style="list-style-type: none"> Max. operating flow: 150 ... 3,200 l/min Medium temperature: -20 ... +100 °C
Output signal	<ul style="list-style-type: none"> 2 switch points Switch point repeatability: ±5 % of span
Process connection	<ul style="list-style-type: none"> 1" NPT male per ASME B1.20.1 1" BSPT male per ISO 7

Data sheet FL 60.01



FSFD

Flow switch for wet sprinkler systems

Flow rate / Sensitivity	4 ... 10 GPM [15 ... 38 LPM]
Switching function	2 x SPDT (single pole double throw), form C
Data sheet	FL 50.01

Electromagnetic flow meters



FLC-608

Hybrid signal converter for electromagnetic flow meters

Special feature	<ul style="list-style-type: none"> Available in different versions of installation and power supply HART® protocol and module for pressure and temperature readout available
Standards	<ul style="list-style-type: none"> EMC directive EN 61326 emission (group 1, class B) and immunity (industrial application)

Data sheet FL 20.05



FLC-2200EL

For water-cycle and process applications

DN	<ul style="list-style-type: none"> 15 ... 2,000 mm 0.5 ... 80 in
Flow tube lining material	<ul style="list-style-type: none"> PTFE – standard for pipe diameters DN 15 ... DN 100, on request also for DN > 100 Hard rubber (ebonite) – for diameter ≥ DN 125
Standards	<ul style="list-style-type: none"> ATEX (option for separated version) IECEx (option for separated version) MID MI-001 and OIML R49 for custody transfer

Data sheet FL 20.01



FLC-1222

Retractable electromagnetic insertion sensor

DN	<ul style="list-style-type: none"> 50 ... 2,600 mm 2 ... 104 in
Special feature	<ul style="list-style-type: none"> "Hot-tapping" installation possible (drilling of pipelines under pressure) Pressure gauge connection available 1" GAS or 1" NPT stopcock No moving parts and no pressure loss
Standards	<ul style="list-style-type: none"> ATEX (option for separated version) IECEx (option for separated version)

Data sheet FL 20.07

New opportunities for growth through holistic IIoT solutions

From measured value to added value

With our innovative complete solutions, we support our customers to become future-proof by offering new added value through the combination and use of digital measured data across the entire value chain.



Real-time monitoring

Predictive algorithms identify potential problems in advance, keep your employees up-to-date and trigger alarms in the event of critical values. This enables automatic or manual interventions to avoid production downtime.



Team productivity

IIoT solutions from WIKA enable the automation of menial, time-consuming tasks to improve the efficiency of your employees. This minimises faults or failures that can arise from human error in repetitive, monotonous tasks.



Safety

WIKA attaches great importance to the protection of your data. With complete end-to-end encryption, bidirectional communication and a cloud solution hosted in the EU, we consistently implement the highest security standards.



Diagnostics and documentation

All measured data is archived to comply with internal and legal requirements. The seamless collection of data allows existing process weaknesses to be identified and eliminated with the help of diagnostic algorithms.



Automation of maintenance

Maintenance actions are initiated automatically, eliminating the need for manual reading and estimating. This allows your team to focus on priority tasks.



Cost reduction

Thanks to a precise, automatic evaluation of the measured data collected, all processes along your value chain can be optimised and unnecessary cost drivers eliminated.

Sensors

- Radio units for measuring instruments
- Measuring instruments with IloT radio unit
- Mobile device app “myWIKa wireless device”

Connectivity

LoRa, mioty, LTE/NB-IoT and 5G networks

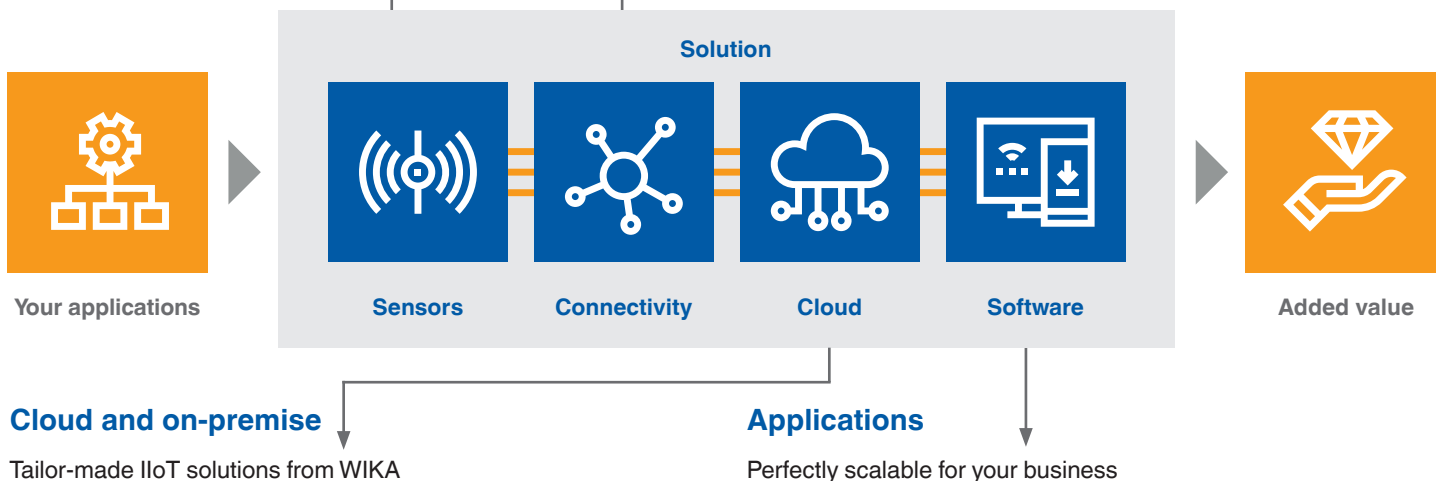

Strong partner in IloT ecosystems

WIKa is a founding member of the mioty alliance, and not only drives the development of pioneering technologies, but also supports industrial standards such as LoRaWAN® and OPC UA. For WIKa, technological leadership has been the key to opening up new markets and applications for over 75 years.

Data security has the highest priority – which is why all WIKa cloud solutions are hosted within the European Union. Our comprehensive IloT offering, based on the latest industry standards, preserves the integrity of your data by encrypting it from end to end.

In order to fully meet the requirements of our customers and to be able to offer flexible solutions that are as compatible as possible, WIKa cooperates with leading technical organisations and companies.

Our partners

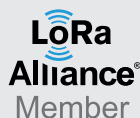

IloT products

Radio units

Wireless transmission via LoRaWAN® (“Long Range Wide Area Network”) is based on LPWAN technology (“Low Power Wide Area Network”) to enable high transmission ranges and long battery life.

The simple web configuration via the cloud and the LoRaWAN® network enable the complete end-to-end encryption with bidirectional communication for safe IloT applications.



NETRIS®1
Radio unit with LoRaWAN® for connection to digital measuring instruments for general industrial applications

Ingress protection	IP65, IP67
Accuracy	<ul style="list-style-type: none"> ■ RTD: $\leq \pm 0.1\%$ of span ■ RTD, potentiometer: $\leq \pm 0.10\%$ of span ■ Analogue: $\leq \pm 0.1\%$ of span
Transmission range	10 km [6 mi]
Function	<ul style="list-style-type: none"> ■ Registration ■ Configuration of measuring and transmission rate ■ Sending measured values ■ Alarm management ■ Battery status
Data sheet	AC 40.01



NETRIS®2
Radio unit with LoRaWAN®, 4 ... 20 mA input signal for connection to measuring instruments in hazardous areas

Ingress protection	IP55
Accuracy class	$\leq \pm 0.5\%$ of span
Transmission range	10 km [6 mi]
Input	Two intrinsically safe analogue inputs for 4 ... 20 mA signals
Function	<ul style="list-style-type: none"> ■ Registration ■ Configuration of measuring and transmission rate ■ Sending measured values ■ Alarm management
Data sheet	AC 40.02



NETRIS®3
Radio unit with LoRaWAN® for connection to digital measuring instruments in hazardous areas

Ingress protection	IP65
Transmission range	10 km [6 mi]
Function	<ul style="list-style-type: none"> ■ Registration ■ Configuration of measuring and transmission rate ■ Sending measured values ■ Alarm management
Data sheet	AC 40.03



NETRIS®F
Radio unit with LoRaWAN® for force measuring instruments

Ingress protection	IP65
Accuracy class	$\leq \pm 0.5\%$ of span
Transmission range	10 km [6 mi]
Function	<ul style="list-style-type: none"> ■ Registration ■ Configuration ■ Sending measured values ■ Alarm management ■ Battery status
Data sheet	AC 40.10

Measuring instruments

The intelligent configuration allows measurement and transmission intervals that are dependent on the measured value. Continuous measurement is possible.

This means high security with low data and energy consumption. All data is available digitally in a cost-efficient way and allows automated analyses.

For general industrial applications



LoRaWAN  

PEW-1000
Pressure sensor with wireless transmission

Ingress protection	IP54, IP67 and IP65
Accuracy	≤ ±0.5 % of span
Transmission range	10 km [6 mi]
Measuring range	<ul style="list-style-type: none"> ■ 0 ... 0.4 to 0 ... 1,000 bar [0 ... 1 to 0 ... 15,000 psi] ■ Vacuum and ± measuring ranges
Data sheet	PE 87.23





LoRaWAN 

TRW
Resistance thermometer with wireless transmission

Ingress protection	IP67
Accuracy	≤ 0.1 % of span
Transmission range	10 km [6 mi]
Measuring range	-196 ... +500 °C [-321 ... 932 °F]
Data sheet	TE 63.04



LoRaWAN  

PGW23.100, PGW26.100
Bourdon tube pressure gauge with wireless transmission, safety version

Ingress protection	IP54, IP65 (case filling)
Accuracy class	1.0
Transmission range	10 km [6 mi]
Measuring range	<ul style="list-style-type: none"> ■ 0 ... 0.6 to 0 ... 1,600 bar [0 ... 10 to 0 ... 20,000 psi] ■ Vacuum and ± measuring ranges
Data sheet	PV 42.02

IloT products

Digital measuring instruments

For hazardous areas



PGU23.100, PGU26.100

Bourdon tube pressure gauge for connection to NETRIS[®]3 radio unit, safety version

Ingress protection	IP54, IP65 (case filling)
Accuracy class	1.0
Measuring range	<ul style="list-style-type: none"> ■ 0 ... 0.6 to 0 ... 1,600 bar [0 ... 10 to 0 ... 20,000 psi] ■ Vacuum and ± measuring ranges
Data sheet	PV 42.03



PEU-20, PEU-21

Pressure transmitter for connection to NETRIS[®]3 radio unit

Ingress protection	IP66/IP67
Accuracy	<ul style="list-style-type: none"> ■ ≤ 0.1 % of span ■ ≤ 0.5 % of span at > 1,000 bar
Process connection for hygienic applications	
Measuring range	<ul style="list-style-type: none"> ■ 0 ... 1 to 0 ... 1,600 bar [0 ... 15 to 0 ... 20,000 psi] ■ Vacuum and ± measuring range
Data sheet	PE 87.24



TGU73.100

Gas-actuated thermometer for connection to NETRIS[®]3 radio unit

Ingress protection	IP65
Accuracy class	2.0
Measuring range	-170 ... +600 °C [-274 ... +1,112 °F]
Data sheet	TV 17.13



TRU

Miniature resistance thermometer for connection to NETRIS[®]3 radio unit

Ingress protection	IP66, IP67
Accuracy	<ul style="list-style-type: none"> ■ Measuring range ≤ 300 °C: ±1.9 °K ■ Measuring range ≤ 300 °C: ±2.9 °K
Measuring range	-196 ... +500 °C [-321 ... 932 °F]
Data sheet	TE 63.03



FLRU

Reed level transmitter for connection to NETRIS[®]3 radio unit

Ingress protection	IP66, IP68
Accuracy	<ul style="list-style-type: none"> ■ 2.7 mm [0.11 in] ■ 5.5 mm [0.22 in] ■ 7.5 mm [0.30 in] ■ 9 mm [0.35 in]
Guide tube length	Max. 6,000 mm [236.22 in]
Data sheet	LM 20.13

Digital pressure gauges

High-quality digital pressure gauges from WIKA

Precision digital pressure gauges are suitable for stationary and also mobile measurement and indication of pressures. In addition, a digital pressure gauge can be used as a pressure reference and enables the easy testing, adjustment and calibration of other pressure measuring equipment directly on-site. Through efficient measuring cells with electronic linearisation of the characteristic curve, a high accuracy is achieved.



CPG1200

Digital pressure gauge

Measuring range	-1 ... 1,000 bar
Accuracy	Down to 0.25 % FS
Special feature	<ul style="list-style-type: none"> ■ Integrated data logger ■ WIKA-Cal compatible ■ Data transmission via USB or Bluetooth® ■ Robust case, IP65

Data sheet CT 10.20



CPG1500

Precision digital pressure gauge

Measuring range	0 ... 10,000 bar
Accuracy	Down to 0.025 % FS
Special feature	<ul style="list-style-type: none"> ■ Integrated data logger ■ WIKA-Cal compatible ■ Data transmission via Bluetooth® ■ Password protection possible ■ Robust case, IP65

Data sheet CT 10.51



DTK1X00

Test case incl. digital pressure gauge model CPG1200 or CPG1500

Simple data transmission via USB or Bluetooth®

Optional data logger for up to 1 million data points

Precise adjustment through the fine adjustment valve

Clear and simple operation

The right hand test pump for every pressure range

Data sheet: CT 93.03



DMK1200

Measuring case incl. digital pressure gauge model CPG1200

Simple data transmission via USB or Bluetooth®

Optional data logger for up to 1 million data points

Supports the series MINIMESS® 1620 or MINIMESS® 1215 quick coupling systems

Data sheet: CT 93.04

Hand-helds, calibrators

Hand-helds are portable calibration instruments for mobile use for the accurate measurement and recording of pressure profiles. There are interchangeable pressure sensors with measuring ranges of up to 10,000 bar available for the instruments. Through this, hand-helds are particularly suitable as test instruments for a

large variety of applications in the widest range of industries. Data recorded in the hand-held can be evaluated via PC software, some instruments document calibrations in the internal memory, which are later read on a PC. Optionally, a calibration certificate can be generated with our calibration software WIKA-Cal.



CPH7000, CPH7000-Ex
Portable process calibrator

Measuring range	-1 ... 25 bar (-1 ... 10,000 bar with CPT7000)
Accuracy	0.025 % FS
Special feature	<ul style="list-style-type: none"> ■ Integrated pressure generation ■ Measurement of pressure, temperature, current, voltage, ambient conditions ■ Data transmission via WIKA-Wireless ■ Supply of pressure, current and voltage ■ Calibration function, data logger, switch test
Data sheet	CT 15.51



CPH8000
Portable multi-function calibrator

Measuring range	-1 ... 700 bar
Accuracy	0.025 % FS
Special feature	<ul style="list-style-type: none"> ■ Large display with touchscreen ■ Integrated data logger and calibration function ■ Measurement and simulation of temperature, current, voltage, resistance, frequency, pressure ■ HART® communication
Data sheet	CT 18.03



WIKA-Cal
Calibration software, accessories for digital pressure gauges

Creation of calibration certificates for mechanical and electronic pressure measuring instruments
Fully automatic calibration with pressure controllers
For the recording of certificate-relevant data in combination with the CalibratorUnits of the CPU6000 series
Determination of the required mass loads for pressure balances
Calibration of gauge pressure measuring instruments with absolute pressure references and vice versa
Data sheet: CT 95.10



Complete test and service cases

These cases can be assembled exactly to your requirements. Thus you will be fully equipped on-site!

Precision pressure measuring instruments

Precision pressure measuring instruments are electrical measuring systems which convert pressure into an electrical signal and optionally visualise it. Precise pressure transmitters and process transmitters are used for the monitoring and control of particularly sensitive processes.

Due to the low, DAKS-accredited measurement uncertainty of down to 0.008 % of the entire measuring chain, the particularly accurate instruments find their primary applications as a factory/working standard for testing and/or calibrating a variety of pressure measuring instruments.



ERC

CPT2500
USB pressure sensor

Measuring range	0 ... 0.025 to 0 ... 1,000 bar
Accuracy	0.2 %, 0.1 % (optional)
Special feature	<ul style="list-style-type: none"> Recording interval adjustable from 1 ms ... 10 s No external voltage supply required Data storage and evaluation directly via PC
Data sheet	CT 05.01



mensor

CPT6030
Analogue pressure transducer

Measuring range	0 ... 0.025 to 0 ... 1,000 bar
Accuracy	0.025 %
Medium	Non-corrosive gases, liquids > 350 mbar
Special feature	<ul style="list-style-type: none"> Comp. temperature range -20 ... +75 °C 4 ... 20 mA DC 15 ... 28 V Ingress protection IP67
Data sheet	CT 25.14



mensor

CPT6100, CPT6140, CPT6180
Precision pressure transducer

Measuring range	0 ... 0.025 to 0 ... 400 bar
Accuracy	<ul style="list-style-type: none"> CPT6100, CPT6180: 0.01 % CPT6140: 0.025 %
Medium	Non-corrosive gases, liquids > 1 bar
Special feature	<ul style="list-style-type: none"> RS-232 or RS-485 connection Analogue output (optional) Barometric measuring range: 552 ... 1,172 mbar abs., 0.01 % of reading Measuring rate of 4 ms at CPT6140
Data sheet	CPT6140: CT 25.11 CPT6100, 6180: CT 25.10



mensor

CPT9000, CPT6020
Precision pressure transducer

Measuring range	0 ... 0.025 to 0 ... 1,000 bar
Accuracy	<ul style="list-style-type: none"> CPT9000: 0.008 % CPT6020: 0.02 %
Medium	Non-corrosive gases, liquids > 350 mbar
Special feature	<ul style="list-style-type: none"> Comp. temperature range 0 ... 50 °C RS-232 or RS-485 Measuring rate 20 ms Barometric measuring range: 552 ... 1,172 mbar abs., 0.008 % of reading Resolution 100 ppb or better
Data sheet	CPT9000: CT 25.12 CPT6020: CT 25.13



mensor

CPG2500
Precision pressure measuring instrument

Measuring range	0 ... 0.025 to 0 ... 2,890 bar
Accuracy	0.014 %, 0.01 % and 0.008 %
Medium	Non-corrosive gases, liquids > 1 bar
Special feature	<ul style="list-style-type: none"> Up to 2 exchangeable, internal sensors and 1 external sensor of model CPT9000 or CPT6100 Barometric reference (optional) Delta and leak test available
Data sheet	CT 25.02



mensor

CPA2501
Precision air data test indicator

Measuring range	<ul style="list-style-type: none"> Altitudes to 100,000 ft Speeds to 1,150 knots
Accuracy	0.01 %, 0.009 %
Special feature	<ul style="list-style-type: none"> RVSM-compliant Ps, Qc, Ps/Pt or Ps/Qc configuration with virtual channels Altitude and airspeed rate indication
Data sheet	CT 29.02

Pressure controllers

WIKA pressure controllers: Always the right calibration solution

Pressure controllers are electronic controllers which quickly and automatically provide a stable pressure reference. Due to the high accuracy and control stability, pressure controllers are especially suitable as references for production lines and laboratories, in order to carry out automatic testing and/or calibration of all types of sensors.

With pneumatic ranges from 1 mbar to 700 bar and hydraulic ranges to 1,600 bar, the pressure controllers cover a wide range. Each controller represents a breakthrough in control and measurement technology to provide first-class measurement accuracy and highly stable pressure control.

 <p>CPC2000 Low-pressure version</p> <table border="1"> <tr> <td>Measuring range</td> <td>0 ... 1 to 0 ... 1,000 mbar</td> </tr> <tr> <td>Accuracy</td> <td>0.1/0.3 % (for 0 ... 1 mbar)</td> </tr> <tr> <td>Medium</td> <td>Ambient air</td> </tr> <tr> <td>Special feature</td> <td> <ul style="list-style-type: none"> ■ Integrated pressure generation ■ Integrated rechargeable battery </td> </tr> <tr> <td>Data sheet</td> <td>CT 27.51</td> </tr> </table>	Measuring range	0 ... 1 to 0 ... 1,000 mbar	Accuracy	0.1/0.3 % (for 0 ... 1 mbar)	Medium	Ambient air	Special feature	<ul style="list-style-type: none"> ■ Integrated pressure generation ■ Integrated rechargeable battery 	Data sheet	CT 27.51	 <p>CPC4000 Industrial series</p> <table border="1"> <tr> <td>Measuring range</td> <td>0 ... 0.35 to 0 ... 210 bar</td> </tr> <tr> <td>Accuracy</td> <td>0.02 %</td> </tr> <tr> <td>Control stability</td> <td>0.005 %</td> </tr> <tr> <td>Medium</td> <td>Dry, clean air or nitrogen</td> </tr> <tr> <td>Special feature</td> <td> <ul style="list-style-type: none"> ■ Up to 2 sensors ■ Fast control speed ■ Leak test function ■ Automatic contamination protection (optional) ■ Up to 24 internal programmable sequences </td> </tr> <tr> <td>Data sheet</td> <td>CT 27.40</td> </tr> </table>	Measuring range	0 ... 0.35 to 0 ... 210 bar	Accuracy	0.02 %	Control stability	0.005 %	Medium	Dry, clean air or nitrogen	Special feature	<ul style="list-style-type: none"> ■ Up to 2 sensors ■ Fast control speed ■ Leak test function ■ Automatic contamination protection (optional) ■ Up to 24 internal programmable sequences 	Data sheet	CT 27.40	 <p>CPC6050 Modular version</p> <table border="1"> <tr> <td>Measuring range</td> <td>0 ... 0.025 to 0 ... 210 bar</td> </tr> <tr> <td>Accuracy</td> <td>0.008 %</td> </tr> <tr> <td>Control stability</td> <td>0.003 %</td> </tr> <tr> <td>Medium</td> <td>Dry, clean air or nitrogen</td> </tr> <tr> <td>Special feature</td> <td> <ul style="list-style-type: none"> ■ Up to 2 control/measuring channels with 2 sensors each ■ Sensors exchangeable ■ Switch test function ■ Auto-channel for both controllers ■ Automatic contamination protection (optional) </td> </tr> <tr> <td>Data sheet</td> <td>CT 27.62</td> </tr> </table>	Measuring range	0 ... 0.025 to 0 ... 210 bar	Accuracy	0.008 %	Control stability	0.003 %	Medium	Dry, clean air or nitrogen	Special feature	<ul style="list-style-type: none"> ■ Up to 2 control/measuring channels with 2 sensors each ■ Sensors exchangeable ■ Switch test function ■ Auto-channel for both controllers ■ Automatic contamination protection (optional) 	Data sheet	CT 27.62
Measuring range	0 ... 1 to 0 ... 1,000 mbar																																			
Accuracy	0.1/0.3 % (for 0 ... 1 mbar)																																			
Medium	Ambient air																																			
Special feature	<ul style="list-style-type: none"> ■ Integrated pressure generation ■ Integrated rechargeable battery 																																			
Data sheet	CT 27.51																																			
Measuring range	0 ... 0.35 to 0 ... 210 bar																																			
Accuracy	0.02 %																																			
Control stability	0.005 %																																			
Medium	Dry, clean air or nitrogen																																			
Special feature	<ul style="list-style-type: none"> ■ Up to 2 sensors ■ Fast control speed ■ Leak test function ■ Automatic contamination protection (optional) ■ Up to 24 internal programmable sequences 																																			
Data sheet	CT 27.40																																			
Measuring range	0 ... 0.025 to 0 ... 210 bar																																			
Accuracy	0.008 %																																			
Control stability	0.003 %																																			
Medium	Dry, clean air or nitrogen																																			
Special feature	<ul style="list-style-type: none"> ■ Up to 2 control/measuring channels with 2 sensors each ■ Sensors exchangeable ■ Switch test function ■ Auto-channel for both controllers ■ Automatic contamination protection (optional) 																																			
Data sheet	CT 27.62																																			



CPC8000

Pneumatic pressure controller, premium version

Measuring range	0 ... 0.35 to 0 ... 400 bar
Accuracy	0.01 ... 0.008 %
Control stability	0.002 %
Medium	Dry, clean air or nitrogen
Special feature	<ul style="list-style-type: none"> ■ Excellent control stability and pressure control without overshooting ■ Up to three interchangeable sensors ■ Optional barometer for automatic conversion of the pressure type ■ Control performance can be matched to application
Data sheet	CT 28.01



CPC7000

Pneumatic pressure controller, high-pressure version

Measuring range	0 ... 100 bar to 0 ... 700 bar
Accuracy	0.01 %
Control stability	0.008 %
Medium	Nitrogen
Special feature	<ul style="list-style-type: none"> ■ Robust and low-wear valve technology with long-term stability ■ Up to three interchangeable sensors ■ 6 x digital I/O ■ High-pressure safety
Data sheet	CT 27.63



CPC8000-H

Hydraulic pressure controller, high-pressure version

Measuring range	0 ... 100 to 0 ... 2,895 bar
Accuracy	0.014 % ... 0.01 %
Control stability	0.005 %
Medium	Hydraulic oil or water
Special feature	<ul style="list-style-type: none"> ■ High stability ■ Up to two interchangeable reference sensors ■ Automatic flooding ■ Hydraulic liquids available, e.g. Sebacate, Shell Tellus 22, Krytox, FC77
Data sheet	CT 28.05

For aviation

An air data test set is an electronic controller which provides a pressure at a variable and adjustable rate.

Air data test sets are specifically developed to convert the pressure to be controlled into a height or rate of climb and velocity. As a result of the high accuracy, control stability and ability to simulate altitude and velocity, an air data test set is particularly suitable as a reference for aircraft workshops and also for instrument manufacturers and calibration laboratories in the aviation industry, in order to make calibrations on sensors and displays.



CPA8001

Air data test set

Measuring range	<ul style="list-style-type: none"> ■ Altitudes to 100,000 ft ■ Speeds to 1,150 knots
Accuracy	0.01 % ... 0.009 %
Control stability	0.002 %
Medium	Dry, clean air or nitrogen
Special feature	<ul style="list-style-type: none"> ■ Excellent control stability, even with rate control ■ Overshoot-free control ■ RVSM compatible ■ Configurations Ps/Pt, Ps/Qc
Data sheet	CT 29.01

Pressure balances

Industrial series

Compact and competitively priced dead-weight testers for use on-site or for maintenance and service

The compact dimensions and low weight are key features of these dead-weight testers for their daily use in service and maintenance. With their integrated pressure generation and purely mechanical measurement principle, they are also specifically suited to on-site applications.



CPB3500
Pneumatic compact version

Measuring range	0.015 ... 1 to 1 ... 120 bar
Accuracy	0.015 ... 0.006 %
Medium	Non-corrosive gases
Special feature	<ul style="list-style-type: none"> ■ Compact dimensions and low weight ■ 1 bar piston can be used for positive and negative overpressure
Data sheet	CT 31.22



CPB3800
Hydraulic compact version

Measuring range	1 ... 120 to 10 ... 1,200 bar
Accuracy	0.05 ... 0.025 %
Medium	Special oil
Special feature	<ul style="list-style-type: none"> ■ Compact dimensions and low weight ■ Instrument base can now also be combined with the CPB5800 piston-cylinder systems
Data sheet	CT 31.06



CPB3800HP
Compact, high-pressure version with dual-range piston-cylinder system

Measuring range	1 ... 2,600 bar
Accuracy	0.025 ... 0.007 %
Medium	Special oil or others on request
Special feature	<ul style="list-style-type: none"> ■ Dual-range piston-cylinder systems with automatic changing between ranges ■ Compact dimensions and low weight
Data sheet	CT 31.07

CPU6000 series CalibratorUnit



Determination of the required mass loads or the reference pressure for calibration with pressure balances

Recording of certificate-relevant data

Calibration of gauge pressure measuring instruments with absolute pressure references and vice versa

Easy calibration of pressure transmitters through the voltage supply and multimeter function

Data sheet: CT 35.02

Laboratory version

High-performance primary standards with excellent running characteristics for use in calibration laboratories

Through modern instrument design with excellent equipment features, the highest demands of operator convenience and performance are fulfilled. The selection of dual-range piston-cylinder systems with automatic changing between ranges can ensure this measurement uncertainty over a large pressure range, even with a single measuring system.



CPB5000
Pneumatic version

Measuring range	-0.03 ... -1 to 0.4 ... 100 bar
Accuracy	0.015 ... 0.008 %
Medium	Non-corrosive gases
Special feature	Patented system for fast piston-cylinder exchange
Data sheet	CT 31.01



CPB5000HP
High-pressure version

Measuring range	25 ... 2,500 to 25 ... 6,000 bar
Accuracy	0.025 ... 0.02 %
Medium	Special oil
Special feature	Robust instrument base with integrated high-pressure generation
Data sheet	CT 31.51



CPB5800
Hydraulic version with dual-range piston-cylinder systems

Measuring range	1 ... 120 to 1 ... 1,400 bar
Accuracy	0.015 ... 0.006 %
Medium	Special oil or others on request
Special feature	<ul style="list-style-type: none"> ■ Dual-range piston-cylinder systems with automatic changing between ranges ■ Instrument base can now also be combined with the CPS5000 piston-cylinder systems
Data sheet	CT 31.11

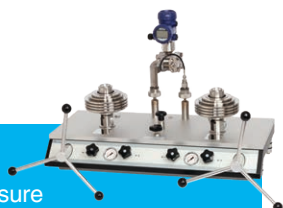

CPB5600DP
Differential pressure version

Measuring range	0.03 ... 2 to 25 ... 1,600 bar
Accuracy	0.015 ... 0.008 %
Medium	Non-corrosive gases or special oil
Special feature	Two complete pressure balances within one case for real differential pressure measurements under static pressure
Data sheet	CT 31.56

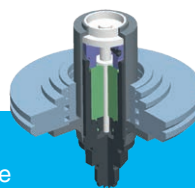

CPS5000
Hydraulic single-range piston-cylinder systems

Special feature	<ul style="list-style-type: none"> ■ For the highest demands on accuracy and performance ■ Can be combined with the CPB5800 instrument base
Data sheet	CT 31.01

Pressure balances

High-end version

High-accuracy and high-performance primary standards with excellent operating characteristics, based on the physical principle of Pressure = Force/Area

The direct measurement of the pressure ($p = F/A$), as well as the use of high-quality materials enable this small measurement uncertainty, in conjunction with an excellent long-term stability (recommended calibration interval of five years in accordance with the German Calibration Service DKD/DAkkS). Furthermore, an automatic mass handling system and pressure generation ensure fully automatic calibration. The pressure balance has therefore been used for years in factory and calibration laboratories in industry, national institutes and research laboratories, and also in production by sensor and transmitter manufacturers.



CPB6000
Highest-accuracy primary standard

Measuring range	4 ... 5,000 bar
Accuracy	0.0035 ... 0.0015 %
Medium	Dry, clean air, nitrogen or special oil
Special feature	Different instrument variants for the highest demands
Data sheet	CT 32.01



CPB6000DP
Primary standard for differential pressure

Measuring range	30 ... 800 bar
Accuracy	0.005 ... 0.002 %
Medium	Non-corrosive gases
Special feature	For differential pressure measurements from 10 Pa to 800 bar
Data sheet	CT 32.02



CPD8500
Digital pressure balance

Measuring range	1 ... 500 bar (abs. and gauge)
Accuracy	0.005 ... 0.0035 %
Medium	Non-corrosive, dry gases
Special feature	<ul style="list-style-type: none"> ■ Unique principle of operation based on SI units ■ Intuitive operator interface ■ Automatic calibrations, no mass handling needed ■ Automatic compensation of the ambient conditions
Data sheet	CT 32.05

Calibration software

Easy and fast creation of a high-quality calibration certificate

WIKA-Cal calibration software enables an automated calibration process with the subsequent creation of calibration certificates (Cal-Template) or logger protocols (Log-Template) for pressure measuring instruments. It is available as a demo version for free download from the homepage. Alongside the simple operation of the software, WIKA-Cal supports the user in the document creation process.

With the purchase of a USB dongle with the desired licence, the range of functions of the demo version is automatically extended while the USB dongle is plugged in and these functions are available so long as the USB dongle is connected to the computer.



WIKA-Cal

Calibration software, accessories for digital pressure gauges

Creation of calibration certificates for mechanical and electronic pressure measuring instruments

Fully automatic calibration with pressure controllers

For the recording of certificate-relevant data in combination with the CalibratorUnits of the CPU6000 series

Determination of the required mass loads for pressure balances

Calibration of gauge pressure measuring instruments with absolute pressure references and vice versa

Data sheet: CT 95.10

In addition to the demo version, three WIKA-Cal licences are available in connection with a precision pressure measuring instrument

The WIKA-Cal calibration software is available for online calibrations together with a PC. The scope of software functions depends on the selected licence. Several licences can be combined on one USB dongle.

Cal-Template (demo version)	Cal-Template (light version)	Cal-Template (full version)
<ul style="list-style-type: none"> Fully automatic calibration Limitation to two measuring points 	<ul style="list-style-type: none"> Semi-automatic calibration No limitation of the measuring points 	<ul style="list-style-type: none"> Fully automatic calibration No limitation of the measuring points
<ul style="list-style-type: none"> Creating calibration certificates per DIN EN 10204 Calibration reports can be exported to Excel® template or XML file Calibration of gauge pressure measuring instruments with absolute pressure references and vice versa 		
Log-Template (demo version)	Log-Template (full version)	
<ul style="list-style-type: none"> Limitation to five measuring points 	<ul style="list-style-type: none"> No limitation of the measuring points 	
<ul style="list-style-type: none"> Live measured value recording for a certain period of time with selectable interval, duration and start time Creation of logger protocols with graphic and/or tabular representation of the measuring results in PDF format Possibility of exporting measuring results as CSV file 		

Multicalibration

The "Multicalibration" licence available for an additional charge can be ordered in addition to Cal Light or Cal. With this, it is possible to calibrate, incl. documentation, up to 16 test items simultaneously. The prerequisite is that the test items are of the same instrument model, measuring range and accuracy.

For pressure sensors, it is possible to use either several multimeters (such as model CPU6000-M, for example) or a multiplexer to which all multimeters will be connected.

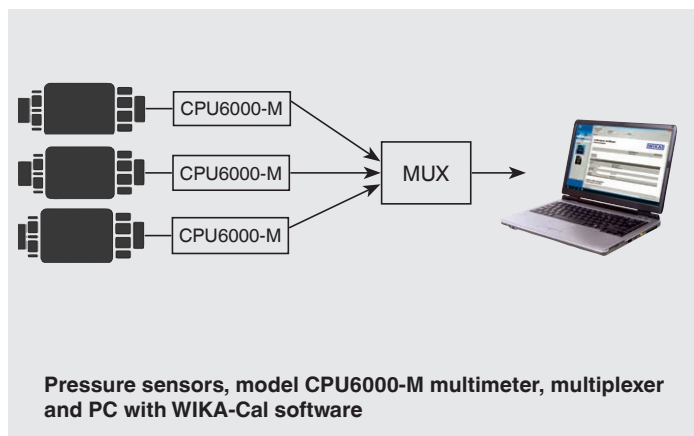

Pressure generation

Portable pressure generation

Hand test pumps serve as pressure generators for the testing, adjustment and calibration of mechanical and electronic pressure measuring instruments through comparative measurements. These pressure tests can take place in the laboratory or workshop, or on-site at the measuring location.



CPP10-H
Pneumatic hand test pump

Measuring range	-0.85 ... +10 bar
Medium	Ambient air
Special feature	<ul style="list-style-type: none"> ■ Switchable pressure/vacuum generation ■ Precise adjustment through the fine adjustment valve ■ Simple and ergonomic handling ■ Compact dimensions and low weight
Data sheet	CT 91.10

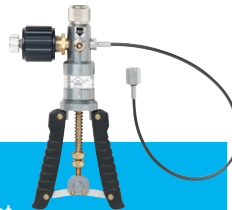

CPP30
Pneumatic hand test pump

Measuring range	-950 mbar ... +35 bar
Medium	Ambient air
Special feature	<ul style="list-style-type: none"> ■ Pressure and vacuum generation switchable ■ Compact dimensions
Data sheet	CT 91.06



CPP700-H, CPP1000-H
Hydraulic hand test pump

Measuring range	0 ... 700 or 0 ... 1,000 bar
Medium	Oil or water
Special feature	<ul style="list-style-type: none"> ■ Integrated medium reservoir ■ Ergonomic handling
Data sheet	CT 91.07

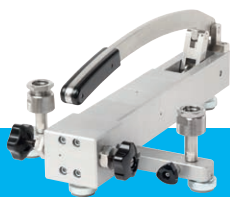

CPP140-M
Pneumatic comparison test pump

Pressure range	-0.95 ... +140 bar [-14 ... +2,000 psi]
Pressure transmission medium	Air
Special feature	<ul style="list-style-type: none"> ■ Precise setting of the test pressure through a fine adjustment valve ■ Pressure connections with quick-release connector and knurled nut for easy and optimal positioning of the measuring instruments
Data sheet	CT 91.14

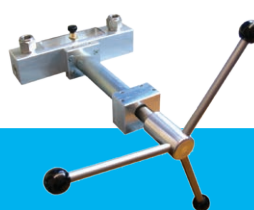

CPP1000-M, CPP1000-L
Hydraulic hand spindle pump

Measuring range	0 ... 1,000 bar
Medium	Oil or water
Special feature	<ul style="list-style-type: none"> ■ Smooth-running, internally operating precision spindle ■ Compact dimensions
Data sheet	CT 91.05

Pressure generation in the laboratory

Comparison test pumps serve as pressure generators or controllers for the testing, adjustment and calibration of mechanical and electronic pressure measuring instruments. Due to their stable case, these test pumps are particularly suitable for stationary use in laboratories or workshops.

CPP120-X

Pneumatic comparison test pump



Measuring range	0 ... 120 bar
Medium	Clean, dry, non-corrosive gases
Special feature	<ul style="list-style-type: none"> ■ Accurate pressure setting ■ Robust industrial series ■ External initial pressure supply necessary
Data sheet	CT 91.03

CPP1200-X

Hydraulic comparison test pump



Measuring range	0 ... 1,200 bar
Medium	Oil or water
Special feature	<ul style="list-style-type: none"> ■ Integrated tank ■ Dual-area spindle pump ■ Robust industrial series
Data sheet	CT 91.08

CPP4000-X

Hydraulic comparison test pump



Measuring range	0 ... 1,200 bar
Medium	Oil or water
Special feature	<ul style="list-style-type: none"> ■ Integrated tank ■ Dual-area spindle pump ■ Robust industrial series
Data sheet	CT 91.09

CPP1000-X, CPP1600-X

Hydraulic comparison test pump

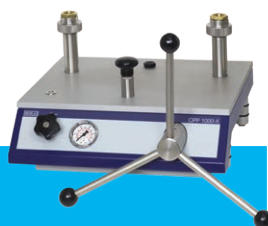

Measuring range	0 ... 1,000 to 0 ... 1,600 bar
Medium	Oil or water
Special feature	<ul style="list-style-type: none"> ■ Integrated tank ■ Robust laboratory version with priming pump ■ Compact industrial series with priming pump
Data sheet	CT 91.12

CPP7000-X

Hydraulic comparison test pump

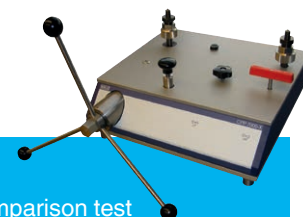

Measuring range	0 ... 7,000 bar
Medium	Sebacate oil
Special feature	<ul style="list-style-type: none"> ■ Integrated tank ■ Robust laboratory version with priming pump
Data sheet	CT 91.13

Reference thermometers

Highly accurate temperature measurement with reference thermometers

Reference thermometers (standard thermometers) are, due to their excellent stability and their geometrical adaptations, ideally suited for applications in industrial laboratories. They enable easy comparative calibration in baths, in tube furnaces and in dry-well calibrators. The advantage of reference thermometers is the wide temperature range, and with this, their flexible operation. Furthermore, with their low drift, a long service life is ensured.

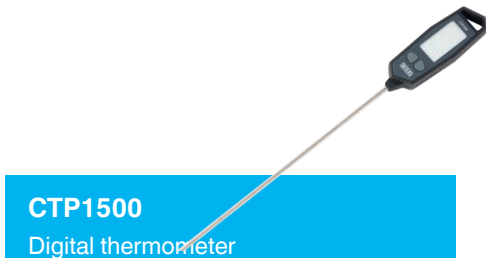

CTP1500
Digital thermometer

Measuring range	-50 ... +250 °C
Accuracy	<ul style="list-style-type: none"> ■ ±0.05 K at -20 ... +180 °C ■ ±0.15 K in remainder of range
Dimension	Depending on version
Special feature	<ul style="list-style-type: none"> ■ Digital display in the handle ■ Battery-powered
Data sheet	CT 61.05



CTP2000
Platinum resistance thermometer

Measuring range	-200 ... +450 °C
Stability	< 50 mK after 100 h at 450 °C
Dimension	Ø 4 mm, l = 500 mm
Special feature	<ul style="list-style-type: none"> ■ 4-wire connection ■ Ends with 4 mm banana plugs
Data sheet	CT 61.10



CTP5000
Reference thermometer

Measuring range	-196 ... +660 °C
Probe type	Pt100, Pt25
Dimension	Depending on version
Special feature	<ul style="list-style-type: none"> ■ Flying leads ■ DIN or SMART connector
Data sheet	CT 61.20



CTP6000
Reference thermometer

Measuring range	-200 ... +420 °C
Probe type	Pt100
Dimension	Depending on version
Special feature	<ul style="list-style-type: none"> ■ Flying leads ■ DIN or SMART connector
Data sheet	CT 61.30

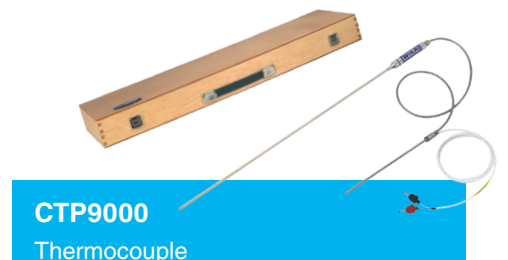

CTP9000
Thermocouple

Measuring range	0 ... 1,600 °C
Thermocouple	Type S per IEC 584, class 1
Dimension	Depending on version
Special feature	<ul style="list-style-type: none"> ■ Cold junction optional ■ 2,000 mm cable
Data sheet	CT 61.10

Hand-helds

Hand-helds are portable calibration instruments for mobile use for the accurate measurement and recording of temperature profiles. For the instruments there are various designs of thermometers available. Through this, hand-helds are particularly suitable as test instruments for a large variety of applications in the widest range of industries.

Data recorded in the hand-held can be evaluated via PC software, some instruments document calibrations in the internal memory, which are later read on a PC. Optionally, a calibration certificate can be generated with our calibration software WIKA-Cal.

EAC



CTH6300, CTH6310

Hand-held thermometer



Measuring range -200 ... +1,500 °C

Accuracy 0.1 ... 1 K

Probe type Pt100, TC

Special feature ■ 2 channels (optional)
■ Ex version: Model CTH6310

Data sheet CT 51.05

EAC



CTH6500, CTH6510

Hand-held thermometer



Measuring range -200 ... +1,500 °C

Accuracy 0.03 ... 0.2 K

Probe type Pt100, TC

Special feature ■ Integrated data logger (optional)
■ Ex version: Model CTH6510

Data sheet CT 55.10

EAC

CTH7000

Hand-held thermometer

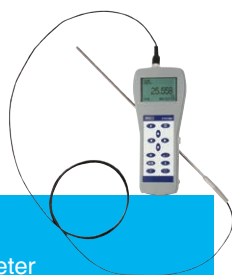

Measuring range -200 ... +962 °C

Accuracy 0.015 K

Probe type Pt100, Pt25 and NTC

Special feature Integrated data logger

Data sheet CT 55.50

CTR1000

Infrared hand-held
thermometer



Measuring range -60 ... +1,000 °C

Accuracy 2 K or 2 % of reading

Special feature Thermocouple connection (optional)

Data sheet CT 55.21

Calibration baths

Calibration baths are electronic controllers which automatically, quickly and with the help of a liquid supply a temperature. Due to the high reliability, accuracy and exceptional homogeneity in the measuring chamber, calibration baths are particularly suitable as a factory/working standard for the automatic testing and/or calibration of the widest range of temperature probes – independent of diameter. A special micro calibration bath design enables on-site applications.



CTB9100
Micro calibration bath

Measuring range	-35 ... +255 °C
Accuracy	±0.2 ... 0.3 K
Stability	±0.05 K
Special feature	<ul style="list-style-type: none"> ■ Short heating and cooling times ■ Easy to use
Data sheet	CT 46.30



CTM9350-165
Multi-function calibrator,
premium version

Measuring range	-35 ... +165 °C depending on the application
Accuracy	±0.07 ... 0.5 K depending on the application
Immersion depth	150 mm
Special feature	Use as a dry-well calibrator, micro calibration bath, surface temperature calibrator and infrared black body
Data sheet	CT 41.41



CTB9400
Calibration bath,
medium measuring range

Measuring range	28 ... 300 °C
Stability	±0.02 K
Immersion depth	200 mm
Medium	Water, oil or similar media
Data sheet	CT 46.20



CTB9500
Calibration bath,
low measuring range

Measuring range	-45 ... +200 °C
Stability	±0.02 K
Immersion depth	200 mm
Medium	Water, oil or similar media
Data sheet	CT 46.20



**CTB9600-150,
CTB9600-300**
Calibration bath

Measuring range	-40 ... +150 °C or amb. 10 ... 300 °C
Stability	±0.008 K ... ±0.015 K (depending on temperature range)
Immersion depth	500 mm
Medium	Water, oil
Data sheet	CT 46.25

Portable temperature calibrators

Portable temperature calibrators (dry-well calibrators) are electronic controllers which automatically, quickly and dryly supply a temperature. Due to the high reliability, accuracy and simple operation, portable temperature calibrators are particularly suitable as a factory/working standard for the automatic testing and/or calibration of temperature measuring instruments of all types.



CTD9100

Temperature dry-well calibrator

Measuring range	-55 ... +650 °C
Accuracy	±0.15 ... 0.8 K
Stability	±0.01 ... 0.05 K
Immersion depth	150 mm
Data sheet	CT 41.28



CTD4000

Temperature dry-well calibrator

Measuring range	-24 ... 650 °C
Accuracy	0.25 ... 0.5 K
Stability	0.1 ... 0.3 K
Immersion depth	104 mm/150 mm
Data sheet	CT 41.10



CTD9100-1100

High-temperature dry-well calibrator

Measuring range	200 ... 1,100 °C
Accuracy	±3 K
Stability	±0.3 K
Immersion depth	220 mm, bore depth 155 mm
Data sheet	CT 41.29



CTD9350-165, CTD9350-700

Temperature dry-well calibrator, premium version

Measuring range	-35 ... +700 °C
Accuracy	±0.1 K
Stability	±0.008 ... 0.1 K depending on the reference
Immersion depth	150 mm
Data sheet	CT 41.39



CTD9100-375

Compact temperature dry-well calibrator

Measuring range	t_{amb} ... 375 °C
Accuracy	±0.5 ... 0.8 K
Stability	±0.05 K
Immersion depth	100 mm
Data sheet	CT 41.32



CTI5000

Infrared calibrator

Measuring range	50 ... 500 °C
Stability	±0.1 ... 0.4 K
Special feature	Large diameter of measuring surface
Data sheet	CT 41.42



CTM9350-165

Multi-function calibrator, premium version

Measuring range	-35 ... +165 °C depending on the application
Accuracy	±0.07 ... 0.5 K depending on the application
Immersion depth	150 mm
Special feature	Use as a dry-well calibrator, micro calibration bath, surface temperature calibrator and infrared black body
Data sheet	CT 41.41

Resistance thermometry bridges

By using built-in or external standard resistors, resistance thermometry bridges measure resistance ratios with high accuracy, which are indicative of the temperature, among other things. These instruments are not only used in the field of temperature measurement, but – due to their high accuracy – also in electrical laboratories.



CTR2000
Precision thermometer

Measuring range	-200 ... +850 °C
Accuracy	<ul style="list-style-type: none"> ■ 0.01 K (4-wire) ■ 0.03 K (3-wire)
Probe type	Pt100, Pt25
Special feature	<ul style="list-style-type: none"> ■ 3-wire measurement (optional) ■ Up to 8 channels integrated in the instrument (optional)
Data sheet	CT 60.10



CTR3000
Multi-functional precision thermometer

Measuring range	-210 ... +1,820 °C
Accuracy	<ul style="list-style-type: none"> ■ ±0.005 K (4-wire) ■ ±0.03 K (3-wire) ■ ±0.004 % + 2 µV for thermocouples
Probe type	Pt100, Pt25, thermocouples
Special feature	<ul style="list-style-type: none"> ■ Versatile applications by measuring thermocouples and resistance thermometers ■ Logger and scan functions ■ Up to 44 channels possible
Data sheet	CT 60.15



CTS3000
Multiplexer

Measuring range	-210 ... +1,820 °C
Accuracy	<ul style="list-style-type: none"> ■ ±0.005 K (4-wire) ■ ±0.03 K (3-wire) ■ ±0.004 % + 2 µV for thermocouples
Probe type	Pt100, Pt25, thermocouples
Special feature	<ul style="list-style-type: none"> ■ No loss of accuracy ■ Various coupler connectors connectable ■ Complete automatic calibration routines controllable
Data sheet	AC 87.01



CTR6000
DC resistance thermometry bridge

Measuring range	-200 ... +962 °C
Accuracy	±3 mK (full range)
Probe type	PRT, thermistors or fixed resistors
Special feature	<ul style="list-style-type: none"> ■ Expendable to 60 channels (optional) ■ Internal resistors 25 Ω, 100 Ω, 10 kΩ, 100 kΩ
Data sheet	CT 60.30



CTR6500
AC resistance thermometry bridge

Measuring range	-200 ... +962 °C
Accuracy	0.1 ... 1.25 mK depending on resistance ratio
Probe type	SPRT, PRT or fixed resistors
Special feature	<ul style="list-style-type: none"> ■ Expendable to 60 channels (optional) ■ Internal resistors 25 Ω, 100 Ω ■ AC technology
Data sheet	CT 60.40



CTR9000
Primary-standard resistance thermometry bridge

Measuring range	0 ... 260 Ω
Accuracy	0.01 K, optional 0.005 K
Probe type	SPRT, PRT or fixed resistors
Special feature	<ul style="list-style-type: none"> ■ Expendable to 60 channels (optional) ■ 4 selectable standby currents possible (optional) ■ AC technology
Data sheet	CT 60.80

Standard reference resistors, AC/DC

Electrical comparison standard

Reference resistors with high-accuracy, fixed resistance values, which are used in connection with resistance thermometry bridges. They are also used as standards in accredited electrical laboratories.



CER6000-RR
Reference resistor

Resistance value 1, 10, 25, 100, 300, 400, 500, 1,000 and 10,000 Ω

Long-term stability $\lt; 5 \text{ ppm per year}$

Special feature

- Low temperature coefficient
- Rugged stainless steel construction

Data sheet CT 70.30



CER6000-RW
Standard reference resistor

Resistance value 1, 10, 25, 100, 300, 400, 500, 1,000 and 10,000 Ω

Long-term stability $\pm 2 \text{ ppm per year}$
(HS version 0.5 ppm per year)

Special feature

- Low temperature coefficient
- Rugged stainless steel construction

Data sheet CT 70.30

Connections of the reference resistor, model CER6000-RR

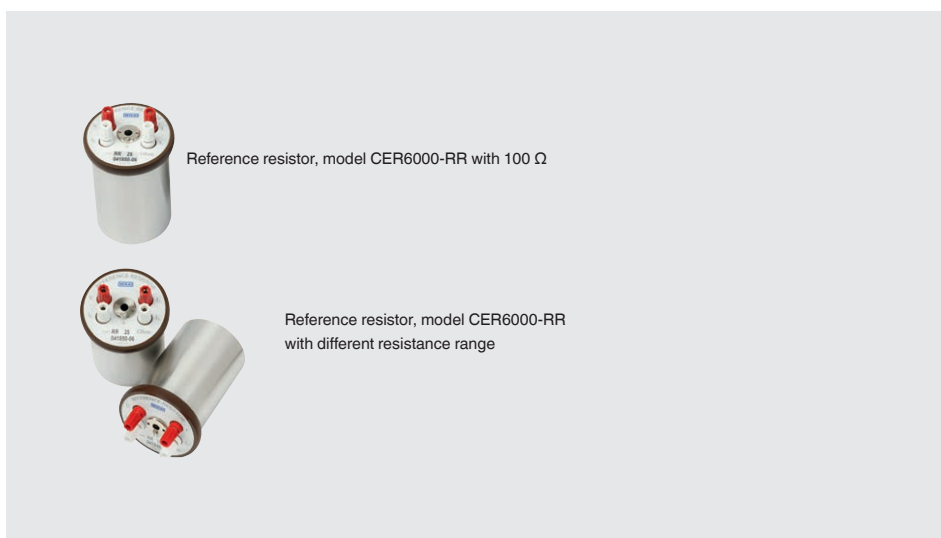
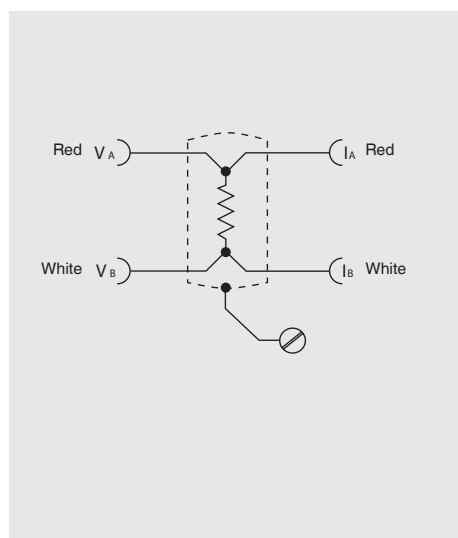

Accessories

From individual components ... to complete turnkey kits

The following accessory components are the ideal complement to the individual calibration instruments. Thus a complete solution is not only quickly and easily configured, but can also be installed in the same manner. The various packages complete the product programme for calibration technology and can be used in many different applications.

Customer-specific drilled inserts, silicone oil suited for calibration in micro calibration baths and interface cables complete the product portfolio for temperature.

You can find a detailed description in our catalogue "Accessories for calibration technology".

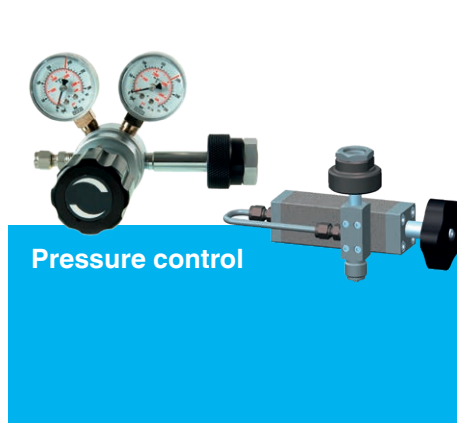

Engineered solutions

We have been developing systems for use in our own group of companies for years and can draw on our own process knowledge to continually develop our systems further.

We offer robust and compact turnkey machinery from a single source, with our own fixture construction and customer-specific solutions as well as many application possibilities.

Test and calibration systems for workshops and laboratories

For the fitting-out of calibration laboratories, we offer individually designed test workstations. Here we integrate proven calibration systems from our extensive product range into ergonomic workstations. These can be individually equipped and combined with the following components:

- 19" calibration racks in modular design for pressure sensors
- Connection columns with quick-release fasteners for test items and references with exchangeable threaded inserts
- Electric and pneumatic power strips with 230-V voltage supply and compressed air with air blow gun connection including pressure regulator
- Work panel for setting the operating pressure with inlet pressure gauge, outlet pressure gauge and alternative pressure supply
- PC workstations



Test and calibration systems for production

The complete solutions are available in the widest range of automation levels incl. tempering units, workpiece transport systems, workpiece fixtures and electrical and pressure-side contacting.

The focus is on the precise interaction of measurement technology, testing system mechanics and control components. In addition, the actual testing and adjustment processes can also be combined with mounting and labelling processes.

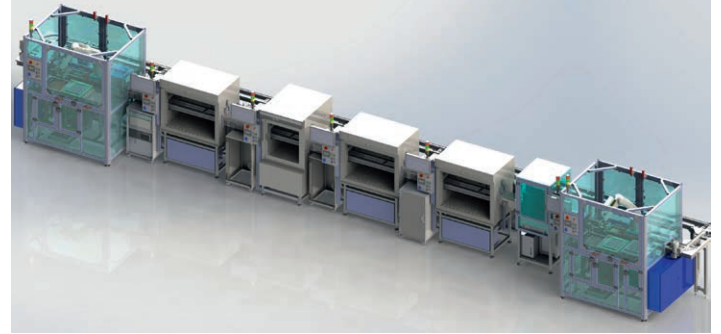

Leak and pressure function test systems for production



We offer individual and turnkey solutions in various degrees of automation for a wide variety of applications, from simple test device through semi-automatic test benches to fully automatic testing systems.

The testing processes can also be combined with assembly processes, laser marking and automated parts handling (infeed/outfeed); in addition, the chaining of several stations is possible.

Pneumatic or helium leak testing

on fittings, valves, hoses, coolers, pumps, filters and many other test parts.

Pressure function tests or setting procedures

among other things for

- Control pressure of pressure reducers or thermostat control valves
- Cracking pressure of relief valves
- Switch points of pressure switches and control valves
- Pressure containment of different components

Test methods

Integral vacuum methods

Accumulation methods (under atmosphere)

Sniffing test

Customer-specific laser welding machines for production

Core elements of our turnkey concept for laser welding systems are a modular axis system, both easily serviced and upgradeable, as well as our own user-friendly, Windows-based control software, for which no programming knowledge is required.

Your benefits:

- We have strong and reliable partners for the laser sources with continuous product development.
- Our systems are equipped with operator software for simple and intuitive operation without needing CNC programming knowledge.
- Our low-service axis concept can also be upgraded at a later date thanks to the modular design of the axes.
- We can be at your side from as early as the preparation of your requirements specification document and offer you the opportunity to influence the entire development phase.



Model GHP-100 from the GHP series

The GHP series features numerous functions and options:

- Camera systems can be integrated to check component positioning
- External interfaces
- CNC axes with servo drives
- Automatic loading possible
- 2- to 5-axis kinematics
- Automatic force-displacement controlled joining function
- Automatic fixture recognition
- Connection to the customer's ERP system

Other models of the GHP series offer further special features.

Service for customer-specific systems

■ Immediate help in case of faults

For the shortest response times and efficient problem analysis we offer a remote service via smart glasses. Using smart glasses, our specialists can efficiently analyse the problem and quickly take targeted corrective action, so you benefit from reduced downtime and costs.

■ Preventive maintenance

Through regular system maintenance, premature wear can be prevented and the risk of system downtime can be minimised. We are happy to advise you regarding the ideal maintenance intervals and to design an individual maintenance package for you.

Service hotline: +49 9372 132 5049



Extensive information can be found in our brochure "Test benches and calibration systems" at www.wika.com.

First-class service thanks to many years of experience

Standardised or customer-specific, anywhere in the world

Service throughout the entire product life cycle

Maximum availability and minimum downtime are among the greatest challenges for manufacturing companies. With us, you have a proven partner at your side who supports you throughout the entire life cycle of products and solutions: from advice through installation and calibration to maintenance and more.



At WIKA



Mobile



At yours



You have specific requirements – We have the experts



Scan for more information
wika.com/service



Always there for you

Short downtimes through customised solutions

Whenever and wherever you need us – products, spare parts and service from one source.

As the market leader in measurement technology with many years of experience, we know the challenges that the integration and operation of measurement technology entail.

This makes us your ideal service partner. We are always at your side to support you in optimising your processes and to take action on your behalf.

Thanks to our global network of service centres and mobile vans, we are always close by and can respond quickly. We advise you individually and offer you customised, individual solutions as well as long-term service agreements.

Inspection and testing

High performance for your systems

We carry out functional tests in your system as proof of the correct functioning of the entire safety-relevant system, including all individual instruments. We are the right people to contact, both during shutdowns and in the event of unplanned breakdowns.

Maintenance and repair

Manufacturer-independent for your instruments

We support you in optimising your operational processes. We ensure that your instruments are available to you again promptly. We always carry out a precise analysis and only replace corrosive or defective parts in order to maximise the service life of your instruments.

Installation and commissioning

Short downtimes through customised solutions

We support you with the installation and commissioning of your instrumentation on-site, and are available to you as a competent service partner. With new projects, corrective maintenance measures as well as for incidents.

Analysis and support

Consulting and problem-solving for many industries

We offer reliable consulting in the analytical and technical field for many industries. Our growing portfolio includes services to optimise your operational processes.

Calibration

Quickly return to reliable measured values

Every measuring instrument is subject to ageing as a result of mechanical, chemical or thermal stress and thus delivers measured values that change over time. This cannot be prevented, but it can be detected in good time by calibration.



Extensive information can be found in our brochure “Service – because measurement technology can do more” at www.wika.com.

Industry-specific products

In our segment brochures you will find industry-specific know-how and special products explicitly developed for specific application areas.

Ventilation and air-conditioning technology



Sensing technology for ventilation and air-conditioning

Our mechanical and electronic instruments are used for measuring and monitoring pressure, air flow, temperature, humidity and air quality.



Sanitary applications



Sanitary applications

Our measuring instruments optimally fulfil requirements in terms of highest process reliability, hygienic design and the integration of sensing technology into production plants.



SF₆ gas solutions

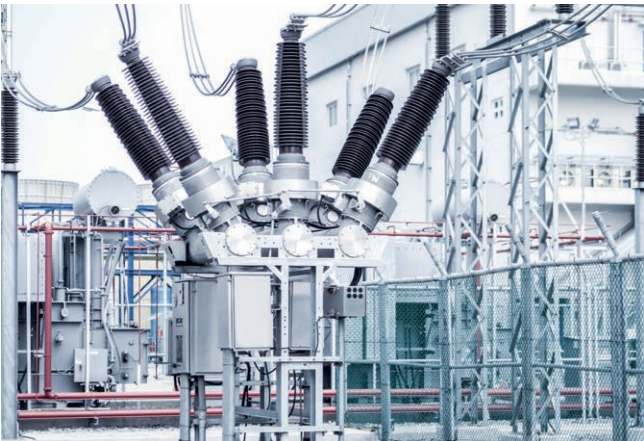

Power transmission and distribution industry

WEgrid Solutions offers customised complete solutions for plants filled with SF₆ gas.



High purity and ultra high purity

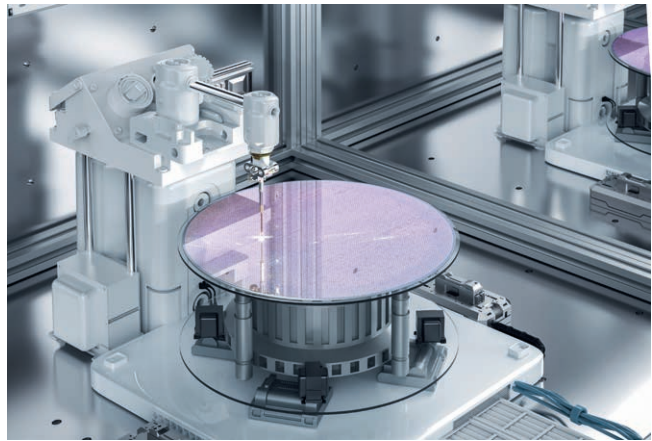

Measurement solutions for semiconductor, solar and light-emitting technologies

High purity, media resistance, leak tightness and accuracy all make up the basic requirements for the development and production of our measuring instruments for the semiconductor industry.



Website and social media

Visit us on our website, in our online shop and on our social media channels.



Website

wika.com

Find out about our wide range of measurement technology and services. Download 3D drawings, technical documents or informative brochures. And please register for our free newsletter!



Online shop

shop.wika.com

Easy, quick and safe:
Directly select the right product for you from our standard product portfolio. Or adapt the instrument you want exactly to your requirements with our configurator.



Blog

blog.wika.com

In our blog, you can expect many interesting articles on the theme of measurement technology. Furthermore, there are various insights into the world of the WIKA Group.



WIKA on LinkedIn

[linkedin.com/company/wikagroup](https://www.linkedin.com/company/wikagroup)

Follow us on LinkedIn. Don't just follow our news on products and applications, but also on important events within the WIKA Group.



WIKA on YouTube

[youtube.com/wikagroup](https://www.youtube.com/wikagroup)

We are happy to welcome you to our YouTube channel. Here we don't just promote our company, but also present complex technical contents, explained in a simple and understandable way.



WIKA on Instagram

[instagram.com/careeratwika/](https://www.instagram.com/careeratwika/)

Follow us on Instagram to stay up to date on exciting career opportunities, events, lotteries and much more.

Notes on the use of registered trademarks

- LoRaWAN® is a trademark used under licence from LoRa Alliance®.
 - The Bluetooth® word mark and logos are registered trademarks owned by Bluetooth SIG, Inc. and any use of such marks by WIKA is under licence.
 - mioty® is a registered trademark of Fraunhofer IIS.
 - VARIVENT® is a registered trademark of the company GEA.
 - BioConnect® is a registered trademark of the company NEUMO.
- Other brands and trademarks are the property of their respective owners.

WIKA worldwide

Europe

Austria

WIKA Messgerätevertrieb
Ursula Wiegand GmbH & Co. KG
Tel. +43 1 8691631
info@wika.at / www.wika.at

Benelux

WIKA Benelux
Tel. +31 475 535500
info@wika.nl / www.wika.nl

Bulgaria

WIKA Bulgaria EOOD
Tel. +359 2 82138-10
info@wika.bg / www.wika.bg

Croatia

WIKA Croatia d.o.o.
Tel. +385 1 6531-034
info@wika.hr / www.wika.hr

Denmark

WIKA Danmark A/S
Tel. +45 4581 9600
info@wika.as / www.wika.as

Finland

WIKA Finland Oy
Tel. +359 9 682492-0
info@wika.fi / www.wika.fi

France

WIKA Instruments s.a.r.l.
Tel. +33 1 71 68 10 00
info@wika.fr / www.wika.fr

Germany

WIKA Alexander Wiegand
SE & Co. KG
Tel. +49 9372 132-0
info@wika.de / www.wika.de

Ireland

WIKA Instruments Ireland Limited
Tel. +35 386 1449 360
info@wika.ie / www.wika.ie

Italy

WIKA Italia S.r.l. & C. S.a.s.
Tel. +39 02 93861-1
info@wika.it / www.wika.it

Poland

WIKA Polska spółka z ograniczoną
odpowiedzialnością sp. k.
Tel. +48 54 230110-0
info@wikapolska.pl
www.wikapolska.pl

Romania

WIKA Instruments Romania S.R.L.
Tel. +40 21 4048327
info@wika.ro / www.wika.ro

Russia

AO "WIKA MERA"
Tel. +7 495-648018-0
info@wika.ru / www.wika.ru

Serbia

WIKA Merna Tehnika d.o.o.
Tel. +381 11 2763722
info@wika.rs / www.wika.rs

Spain

Instrumentos WIKA S.A.U.
Tel. +34 933 9386-30
info@wika.es / www.wika.es

Switzerland

WIKA Schweiz AG
Tel. +41 41 91972-72
info@wika.ch / www.wika.ch

Türkiye

WIKA Instruments
Eayel Ölçüm Cihazları Tic. Ltd. Şti.
Tel. +90 216 41590-66
info@wika.com.tr
www.wika.com.tr

Ukraine

TOV WIKA Prylad
Tel. +38 044 496 83 80
info@wika.ua / www.wika.ua

United Kingdom

WIKA Instruments Ltd
Tel. +44 1737 644-008
info@wika.co.uk / www.wika.co.uk

North America

Canada

WIKA Instruments Ltd.
Tel. +1 780 4637035
info@wika.ca / www.wika.ca

USA

WIKA Instrument, LP
Tel. +1 770 5138200
info@wika.com / www.wika.us

Gayesco-WIKA USA, LP

Tel. +1 713 4750022
info@wikhouston.com
www.wika.us

Mensor Corporation

Tel. +1 512 3964200
sales@mensor.com
www.mensor.com

Latin America

Argentina

WIKA Argentina S.A.
Tel. +54 11 5442 0000
ventas@wika.com.ar
www.wika.com.ar

Brazil

WIKA do Brasil Ind. e Com. Ltda.
Tel. +55 15 3459-9700
vendas@wika.com.br
www.wika.com.br

Chile

WIKA Chile S.p.A.
Tel. +56 2 2964 9440
info@wika.cl / www.wika.cl

Colombia

Instrumentos WIKA Colombia S.A.S.
Tel. +57 601 7021347
info@wika.co / www.wika.co

Mexico

Instrumentos WIKA Mexico S.A. de C.V.
Tel. +52 55 50205300
ventas@wika.com / www.wika.mx

Asia

China

WIKA Instrumentation Suzhou Co., Ltd.
Tel. +86 512 6878 8000
info@wika.cn / www.wika.com.cn

India

WIKA Instruments India Pvt. Ltd.
Tel. +1800-123-101010
info@wika.co.in / www.wika.co.in

Japan

WIKA Japan K. K.
Tel. +81 3 5439-6673
info@wika.co.jp / www.wika.co.jp

Kazakhstan

TOO WIKA Kazakhstan
Tel. +7 727 220 80 08
info@wika.kz / www.wika.kz

Korea

WIKA Korea Ltd.
Tel. +82 2 869-0505
info@wika.co.kr / www.wika.co.kr

Malaysia

WIKA Instrumentation (M) Sdn. Bhd.
Tel. +60 3 5590 6666
info@wika.my / www.wika.my

Philippines

WIKA Instruments Philippines Inc.
Tel. +63 2 234-1270
info@wika.ph / www.wika.ph

Singapore

WIKA Instrumentation Pte. Ltd.
Tel. +65 6844 5506
info@wika.sg / www.wika.sg

Taiwan

WIKA Instrumentation Taiwan Ltd.
Tel. +886 3 420 6052
info@wika.tw / www.wika.tw

Thailand

WIKA Instrumentation Corporation
(Thailand) Co., Ltd.
Tel. +66 2 326 6876
info@wika.co.th / www.wika.co.th

Uzbekistan

WIKA Instrumentation FE LLC
Tel. +998 71 205 84 30
info@wika.uz / www.wika.uz

Africa/Middle East

Botswana

WIKA Instruments Botswana (Pty.) Ltd.
Tel. +267 3110013
info@wika.co.bw / wika.co.bw

Egypt

WIKA Near East Ltd.
Tel. +20 2 240 13130
info@wika.com.eg / www.wika.com.eg

Namibia

WIKA Instruments Namibia Pty Ltd.
Tel. +26 4 61238811
info@wika.com.na / www.wika.com.na

Nigeria

WIKA WEST AFRICA LIMITED
Tel. +234 17130019
info@wika.com.ng / www.wika.ng

Saudi Arabia

WIKA Saudi Arabia LLC
Tel. +966 53 555 0874
info@wika.sa / www.wika.sa

South Africa

WIKA Instruments Pty. Ltd.
Tel. +27 11 62100-00
sales@wika.co.za / www.wika.co.za

United Arab Emirates

WIKA Middle East FZE
Tel. +971 4 883-9090
info@wika.ae / www.wika.ae

Australia

Australia

WIKA Australia Pty. Ltd.
Tel. +61 2 88455222
sales@wika.com.au / www.wika.com.au

New Zealand

WIKA Instruments Limited
Tel. +64 9 8479020
info@wika.co.nz / www.wika.co.nz

WIKA Alexander Wiegand SE & Co. KG
Alexander-Wiegand-Straße 30 | 63911 Klingenberg | Germany
Tel. +49 9372 132-0 | info@wika.de | www.wika.de

12393852 10/2024 EN

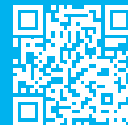

You can find further
information here!



Smart in sensing

www.wika.com