

# Bayonet thermocouple Model TC53

WIKA data sheet TE 65.53



for further approvals  
see page 2

## Applications

- Plastics processing machinery
- Injection moulding machinery
- Cylinder heads and oil sumps in engines
- Bearings
- Pipelines and vessels

## Special features

- Sensor ranges up to max. 1,200 °C (2,193 °F)
- Single and dual thermocouple
- Good heat transfer through adjustable spring-loading
- Easy installation and removal, no tools needed
- Explosion-protected versions



Model TC53 with optional threaded nipple

## Description

### Probe

This cable thermocouple feature a bayonet-type probe connection. TC53 series thermocouples can be mounted into drilled holes without thermowells, e.g. into machine components.

### Cable

There are various insulating materials available to match different environmental conditions. The free ends of the cable are made up ready for connection, or can be fitted with connectors or sockets as optional extras.

## Explosion protection (option)

The permissible power,  $P_{max}$ , as well as the permissible ambient temperature, for the respective category can be seen on the EC-type examination certificate, the certificate for hazardous areas or in the operating instructions.





The internal inductance ( $L_i = 1 \mu\text{H/m}$ ) and capacitance ( $C_i = 200 \text{ pF/m}$ ) for cable probes are found on the product label and they should be taken into account when connecting to an intrinsically safe power supply.











### Note:

When mounting thermometers with flying leads, installation personnel must ensure that installation is carried out properly and in compliance with the appropriate regulations. If the cable ends of the thermometer are within the hazardous area, suitable adapters/connectors must be used. Flying leads must be connected outside the hazardous area or, when operated in a dust explosive atmosphere, within an enclosure which is certified.

The connection of a thermocouple to a transmitter must be made with shielded cable. The shield must be electrically connected to the case of the grounded thermometer. It should be ensured that there is equipotential bonding on installation, so that no balancing current can flow via the shield. Here, in particular, the installation regulations for hazardous areas should be followed!

## Approvals (explosion protection, further approvals)

Logo	Description	Country																								
 	<p><b>EU declaration of conformity</b></p> <ul style="list-style-type: none"> <li>■ RoHS directive</li> <li>■ ATEX directive (option)</li> </ul> <p>Hazardous areas</p> <table border="0"> <tr> <td>- Ex i</td> <td>Zone 0 gas</td> <td>[II 1G Ex ia IIC T1 ... T6 Ga]</td> </tr> <tr> <td></td> <td>Zone 1 mounting to zone 0 gas</td> <td>[II 1/2G Ex ia IIC T1 ... T6 Ga/Gb]</td> </tr> <tr> <td></td> <td>Zone 1 gas</td> <td>[II 2G Ex ia IIC T1 ... T6 Gb]</td> </tr> <tr> <td></td> <td>Zone 20 dust</td> <td>[II 1D Ex ia IIIC T125 ... T65 °C Da]</td> </tr> <tr> <td></td> <td>Zone 21 mounting to zone 20 dust</td> <td>[II 1/2D Ex ia IIIC T125 ... T65 °C Da/Db]</td> </tr> <tr> <td></td> <td>Zone 21 dust</td> <td>[II 2D Ex ia IIIC T125 ... T65 °C Db]</td> </tr> <tr> <td>- Ex n</td> <td>Zone 2 gas</td> <td>[II 3G Ex nA IIC T1 ... T6 Gc X]</td> </tr> <tr> <td></td> <td>Zone 22 dust</td> <td>[II 3D Ex tc IIIC T440 ... T80 °C Dc X]</td> </tr> </table>	- Ex i	Zone 0 gas	[II 1G Ex ia IIC T1 ... T6 Ga]		Zone 1 mounting to zone 0 gas	[II 1/2G Ex ia IIC T1 ... T6 Ga/Gb]		Zone 1 gas	[II 2G Ex ia IIC T1 ... T6 Gb]		Zone 20 dust	[II 1D Ex ia IIIC T125 ... T65 °C Da]		Zone 21 mounting to zone 20 dust	[II 1/2D Ex ia IIIC T125 ... T65 °C Da/Db]		Zone 21 dust	[II 2D Ex ia IIIC T125 ... T65 °C Db]	- Ex n	Zone 2 gas	[II 3G Ex nA IIC T1 ... T6 Gc X]		Zone 22 dust	[II 3D Ex tc IIIC T440 ... T80 °C Dc X]	European Union
- Ex i	Zone 0 gas	[II 1G Ex ia IIC T1 ... T6 Ga]																								
	Zone 1 mounting to zone 0 gas	[II 1/2G Ex ia IIC T1 ... T6 Ga/Gb]																								
	Zone 1 gas	[II 2G Ex ia IIC T1 ... T6 Gb]																								
	Zone 20 dust	[II 1D Ex ia IIIC T125 ... T65 °C Da]																								
	Zone 21 mounting to zone 20 dust	[II 1/2D Ex ia IIIC T125 ... T65 °C Da/Db]																								
	Zone 21 dust	[II 2D Ex ia IIIC T125 ... T65 °C Db]																								
- Ex n	Zone 2 gas	[II 3G Ex nA IIC T1 ... T6 Gc X]																								
	Zone 22 dust	[II 3D Ex tc IIIC T440 ... T80 °C Dc X]																								
 	<p><b>IECEx (option)</b> (in conjunction with ATEX)</p> <p>Hazardous areas</p> <table border="0"> <tr> <td>- Ex i</td> <td>Zone 0 gas</td> <td>[Ex ia IIC T1 ... T6 Ga]</td> </tr> <tr> <td></td> <td>Zone 1 mounting to zone 0 gas</td> <td>[Ex ia IIC T1 ... T6 Ga/Gb]</td> </tr> <tr> <td></td> <td>Zone 1 gas</td> <td>[Ex ia IIC T1 ... T6 Gb]</td> </tr> <tr> <td></td> <td>Zone 20 dust</td> <td>[Ex ia IIIC T125 ... T65 °C Da]</td> </tr> <tr> <td></td> <td>Zone 21 mounting to zone 20 dust</td> <td>[Ex ia IIIC T125 ... T65 °C Da/Db]</td> </tr> <tr> <td></td> <td>Zone 21 dust</td> <td>[Ex ia IIIC T125 ... T65 °C Db]</td> </tr> </table>	- Ex i	Zone 0 gas	[Ex ia IIC T1 ... T6 Ga]		Zone 1 mounting to zone 0 gas	[Ex ia IIC T1 ... T6 Ga/Gb]		Zone 1 gas	[Ex ia IIC T1 ... T6 Gb]		Zone 20 dust	[Ex ia IIIC T125 ... T65 °C Da]		Zone 21 mounting to zone 20 dust	[Ex ia IIIC T125 ... T65 °C Da/Db]		Zone 21 dust	[Ex ia IIIC T125 ... T65 °C Db]	International						
- Ex i	Zone 0 gas	[Ex ia IIC T1 ... T6 Ga]																								
	Zone 1 mounting to zone 0 gas	[Ex ia IIC T1 ... T6 Ga/Gb]																								
	Zone 1 gas	[Ex ia IIC T1 ... T6 Gb]																								
	Zone 20 dust	[Ex ia IIIC T125 ... T65 °C Da]																								
	Zone 21 mounting to zone 20 dust	[Ex ia IIIC T125 ... T65 °C Da/Db]																								
	Zone 21 dust	[Ex ia IIIC T125 ... T65 °C Db]																								

Logo	Description	Country
	<b>EAC (option)</b> Hazardous areas - Ex i Zone 0 gas [0 Ex ia IIC T3/T4/T5/T6] Zone 1 gas [1 Ex ib IIC T3/T4/T5/T6] Zone 20 dust [DIP A20 Ta 65 °C/Ta 95 °C/Ta 125 °C] Zone 21 dust [DIP A21 Ta 65 °C/Ta 95 °C/Ta 125 °C] - Ex n Zone 2 gas [Ex nA IIC T6 ... T1] Zone 22 dust [DIP A22 Ta 80 ... 440 °C]	Eurasian Economic Community
	<b>INMETRO (option)</b> Hazardous areas - Ex i Zone 0 gas [Ex ia IIC T3 ... T6 Ga] Zone 1 mounting to zone 0 gas [Ex ib IIC T3 ... T6 Ga/Gb] Zone 1 gas [Ex ib IIC T3 ... T6 Gb] Zone 20 dust [Ex ia IIIC T125 ... T65 °C Da] Zone 21 mounting to zone 20 dust [Ex ib IIIC T125 ... T65 °C Da/Db] Zone 21 dust [Ex ib IIIC T125 ... T65 °C Db]	Brazil
	<b>NEPSI (option)</b> Hazardous areas - Ex i Zone 0 gas [Ex ia IIC T3 ~ T6] Zone 1 mounting to zone 0 gas [Ex ia/ib IIC T3 ~ T6] Zone 1 gas [Ex ib IIC T3 ~ T6]	China
	<b>KCs - KOSHA (option)</b> Hazardous areas - Ex i Zone 0 gas [Ex ia IIC T4 ... T6] Zone 1 gas [Ex ib IIC T4 ... T6]	South Korea
-	<b>PESO (option)</b> Hazardous areas - Ex i Zone 0 gas [Ex ia IIC T1 ... T6 Ga] Zone 1 mounting to zone 0 gas [Ex ib IIC T3 ... T6 Ga/Gb] Zone 1 gas [Ex ib IIC T3 ... T6 Gb]	India
	<b>DNOP - MakNII (option)</b> Hazardous areas - Ex i Zone 0 gas [II 1G Ex ia IIC T3, T4, T5, T6 Ga] Zone 1 gas [II 2G Ex ia IIC T3, T4, T5, T6 Gb] Zone 20 dust [II 1D Ex ia IIIC T65, T95, T125 °C Da] Zone 21 dust [II 2D Ex ib IIIC T125 ... T65 °C Db]	Ukraine
	<b>GOST (option)</b> Metrology, measurement technology	Russia
	<b>KazInMetr (option)</b> Metrology, measurement technology	Kazakhstan
-	<b>MTSCHS (option)</b> Permission for commissioning	Kazakhstan
	<b>BelGIM (option)</b> Metrology, measurement technology	Belarus
	<b>UkrSEPRO (option)</b> Metrology, measurement technology	Ukraine
	<b>Uzstandard (option)</b> Metrology, measurement technology	Uzbekistan

Instruments marked with "ia" may also be used in areas only requiring instruments marked with "ib" or "ic".  
 If an instrument with "ia" marking has been used in an area with requirements in accordance with "ib" or "ic", it can no longer be operated in areas with requirements in accordance with "ia" afterwards.

Approvals and certificates, see website

## Sensor

### Thermocouple per IEC 60584-1 or ASTM E230

Types K, J, E, N, T (single or dual thermocouple)

#### Sensor types

Type	Operating temperatures of the thermocouple			
	IEC 60584-1		ASTM E230	
	Class 2	Class 1	Standard	Special
K	-40 ... +1,200 °C	-40 ... +1,000 °C	0 ... 1,260 °C	
J	-40 ... +750 °C	-40 ... +750 °C	0 ... 760 °C	
E	-40 ... +900 °C	-40 ... +800 °C	0 ... 870 °C	
N	-40 ... +1,200 °C	-40 ... +1,000 °C	0 ... 1,260 °C	
T	-40 ... +350 °C		0 ... 370 °C	

The table shows the temperature ranges listed in the respective standards, in which the tolerance values (class accuracies) are valid.

The actual application range of these thermometers is limited by the permissible maximum ambient temperature for the cable insulation. For applications of temperatures above 400 °C we recommend sheathed thermocouples.

Listed models are available both as single or dual thermocouples. The thermocouple will be delivered with an ungrounded measuring point, unless explicitly specified otherwise.

For detailed specifications for thermocouples, see IEC 60584-1 or ASTM E230 and Technical information IN 00.23 at [www.wika.com](http://www.wika.com).

#### Tolerance value

For the tolerance value of thermocouples, a cold junction temperature of 0 °C has been taken as the basis.

## Probe

Design: Rigid tube  
Material: Stainless steel  
Diameter: 6 mm or 8 mm  
Length: 10 mm  
other versions on request

For temperature measurement in a solid body, the diameter of the bore into which the sensor should be inserted must be no more than 1 mm larger than the sensor diameter.

## Maximum working temperatures

The maximum working temperature for these thermometers is limited by different parameters.

If the temperature to be measured inside the sensor measuring range is higher than the permissible temperature at the connection cable, the connector or the transition point, the metallic part of the sensor (mineral-insulated cable) must be long enough to place the critical components outside of the hot zone. The lowest of the maximum working temperatures of process connection, connection line, cable transition or connector must be observed here.

#### ■ Sensor (thermocouple)

The temperature ranges indicated on page 4 refer to the operating range of the thermocouple. These measuring ranges depend on the selected thermocouple and the selected accuracy class.

Operation outside the measuring range defined for the given thermocouple type and class can result in a damage to the thermocouple.

#### ■ Connection cable and single wires

At any point on the connection cable, the maximum temperature that may be attained is that for which the connection cable is specified. The sensor itself (see page 5) can potentially withstand higher temperatures.

For the common connection lines the following maximum operating temperatures apply:

PVC	-20 ... +100 °C
Silicone	-50 ... +200 °C
PTFE	-50 ... +250 °C
Fibreglass	-50 ... +400 °C

Since, in the tubular design variant, an isolated cable is also fitted within the metal probe, the operating limits of the connection cable apply.

#### ■ Transition from the metal part of the thermometer to the connection cable

The temperature at the transition is further limited by the use of a potted sealing compound.

Temperature range of the potting compound: -40 ... +150 °C  
Option: 250 °C  
(other variants on request)

Temperature range of the special low-temperature version: -60 ... +120 °C<sup>1)</sup>

<sup>1)</sup> only available with selected approvals

#### ■ Connector (option)

With the option of a coupler connector fitted the maximum permissible temperature range is:

Lemosa:	-55 ... +250 °C
Binder:	-40 ... +85 °C

## Transition

The junction between the metal part of the probe and the connecting cable or wire is either rolled or potted, depending on the design. This area should not be immersed within the process and must not be bent. Compression fittings should not be attached to the transition. The type and dimensions of the transition depend largely on the combination between input leads and metal probe and the sealing requirements.

The dimension T describes the length of the transition.

Criterion	Dimensions T in mm	Ø transition in mm
Probe Ø = transition sleeve Ø	n/a	Identical to probe
Ø 6 mm with crimped transition sleeve	45	7
Ø 6 mm with crimped transition sleeve <sup>2)</sup>	45	8
Ø 8 mm with crimped transition sleeve	45	10

2) With a large number of wires (e. g. 2 x 3-wire and shielding)

## IP ingress protection

Bayonet thermocouples can be delivered with up to IP65 (dependent on cable sheath material and number of wires). With a special design, IP67 is also possible on request.

Connection leads with a glass-fibre sheath cannot be combined with an explosion-proof version.

## Cable

Wire material: Compensating cable depending on type of sensor (stranded wire)  
Wire cross-section: approx. 0.22 mm<sup>2</sup>  
Number of wires: According to the number of sensors  
Abschirmung: Optional  
Wire ends: Blank

### Connecting cable

There are various insulating materials available to match different environmental conditions. The free ends of the cable are made up ready for connection, or can be fitted with connectors or sockets as optional extras.

## Process connection

Bayonet cap on the probe, with matching threaded nipple for screw-fitting to a solid body (process).

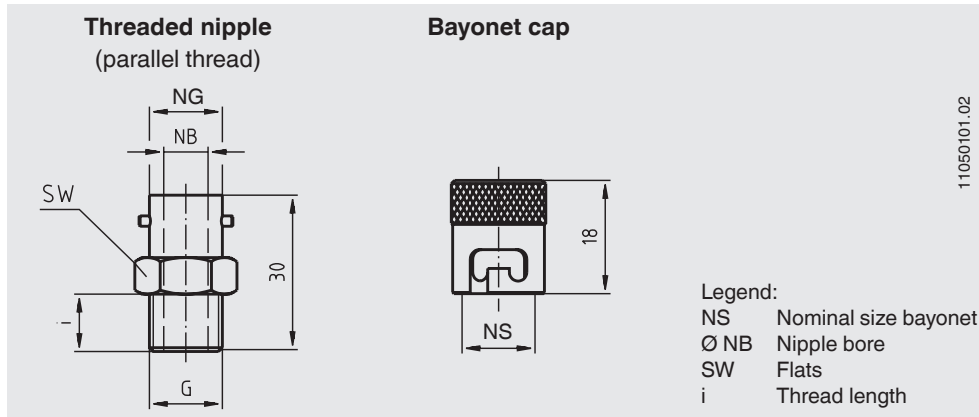

Probe Ø	Process connection	NS	Nipple bore Ø NB	Spring Ø Ø FD	Flats SW	Thread length i	Order no.
<b>6</b>	M10 x 1	12	6,4	6	14	10	3120914
	M14 x 1,5	14	8,4	6	17	10	3366788
	G ¼ B	14	8,4	6	17	10	3118927
	G ⅜ B	14	8,4	6	17	11	3118901
<b>8</b>	M14 x 1,5	14	8,4	7	17	10	3366788
	G ¼ B	14	8,4	7	17	10	3118927
	G ⅜ B	14	8,4	7	17	11	3118901

Material: Brass, nickel-plated

# Dimensions in mm

## Bayonet cap fixed to the end of the spring (sheathed cable design)

Probe tip, flat

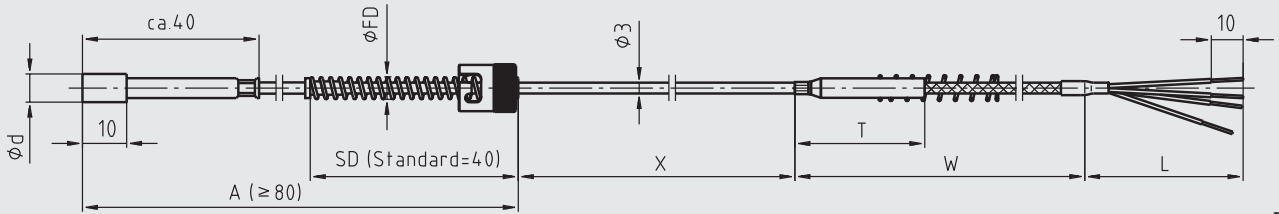

Probe tip, chamfered

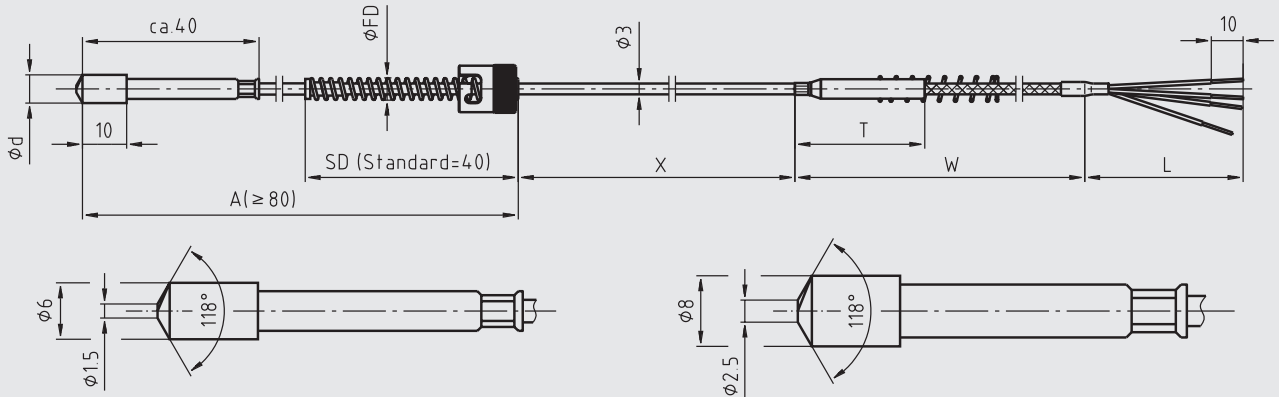

Probe tip, round

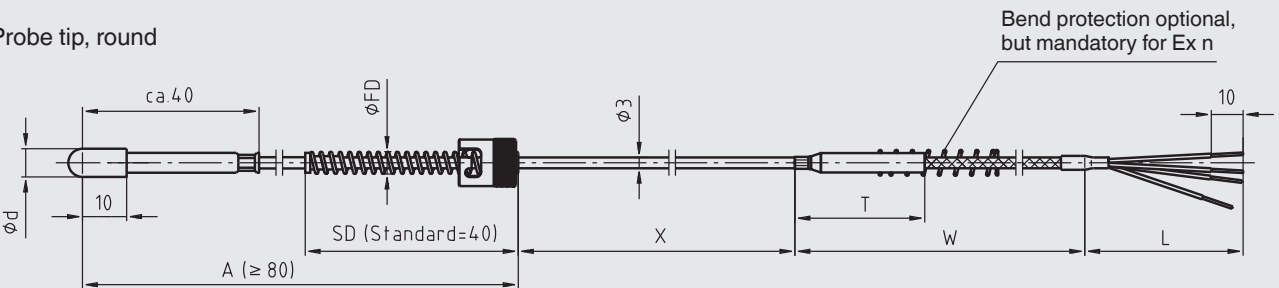

**Legend:**

- Ø d Probe diameter
- L Probe length
- W Cable length
- Ø FD Spring diameter
- A Insertion length
- X Probe extension
- T Transition sleeve
- SD Spring length

11344148.01

## Bayonet cap adjustable on the spring (sheathed cable design)

Probe tip, flat

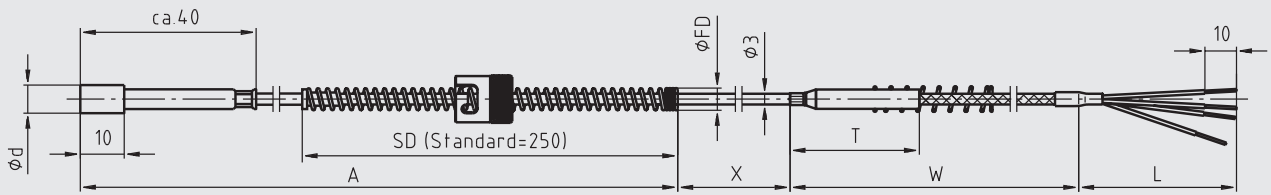

Probe tip, chamfered

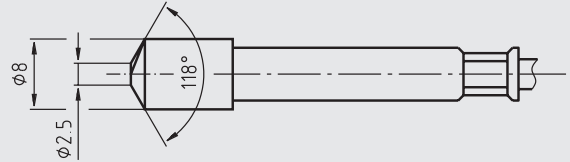
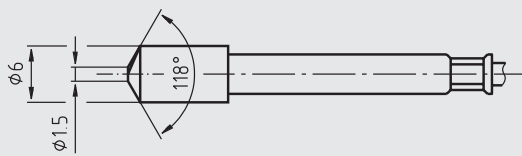
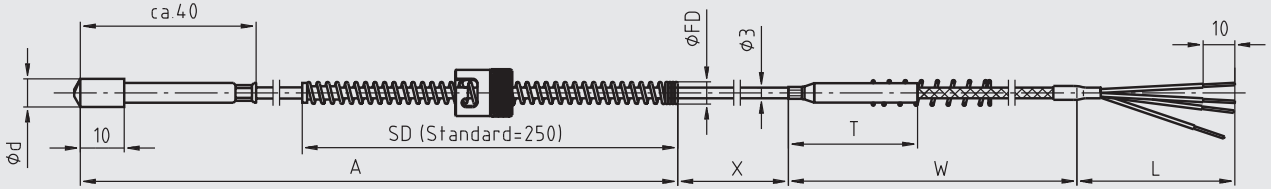

Probe tip, round

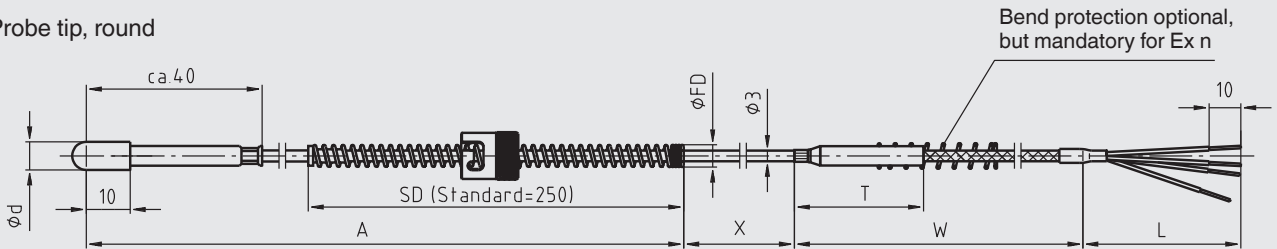

### Legend:

- Ø d Probe diameter
- L Probe length
- W Cable length
- Ø FD Spring diameter
- A Insertion length
- X Probe extension
- T Transition sleeve
- SD Spring length

11343168.02



**Bayonet cap adjustable on the spring (cable through to the probe tip)**

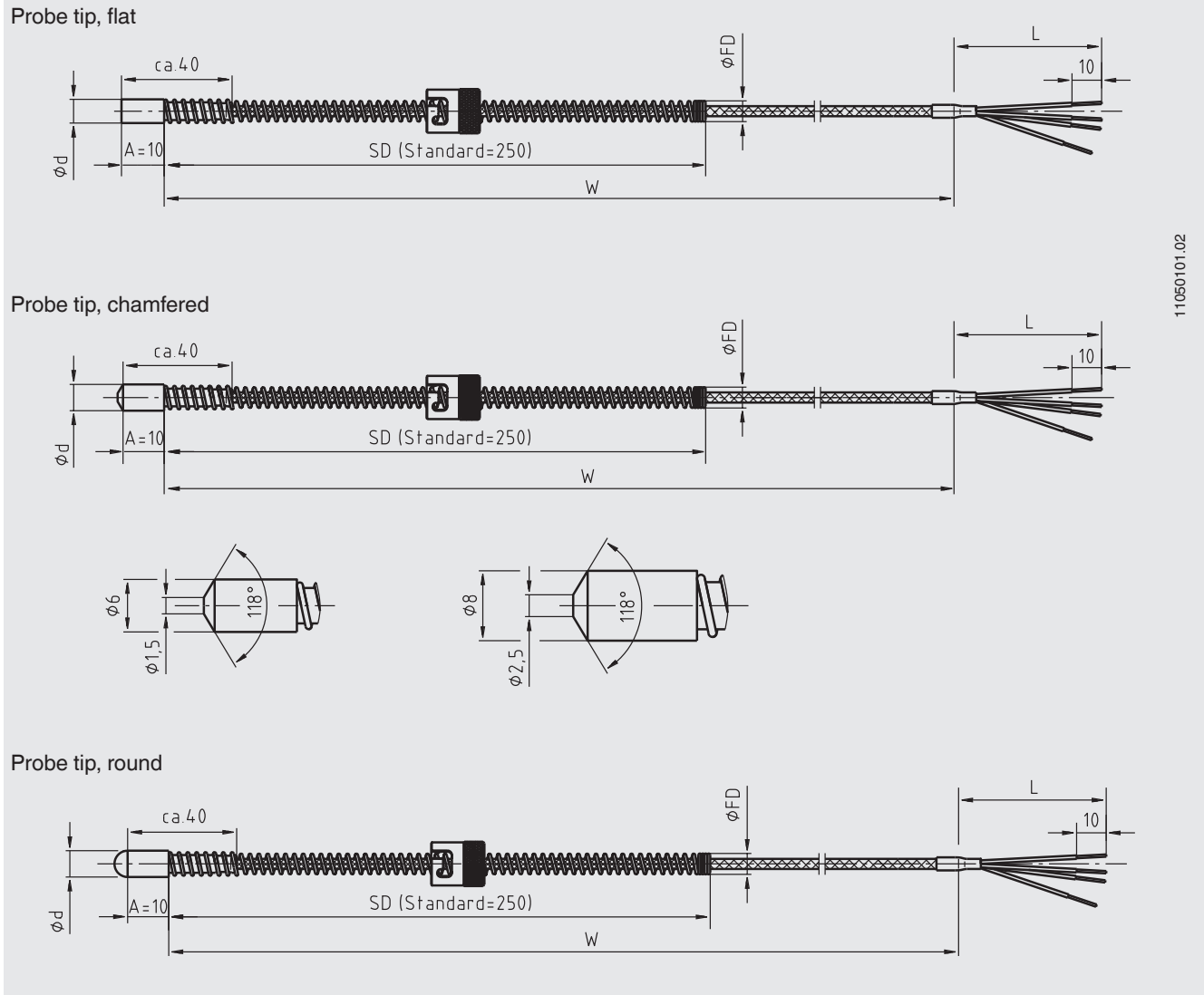

**Legend:**

- ∅ d Probe diameter
- L Probe length
- W Cable length
- ∅ FD Spring diameter
- A Insertion length
- X Probe extension
- T Transition sleeve
- SD Spring length

## Connector (option)

Bayonet thermocouples can be supplied with connectors fitted.  
The following options are available:

- **Screw-in-connector, Binder (male)**

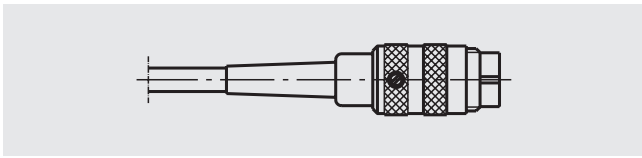

- **Screw-in-connector, Binder (female)**

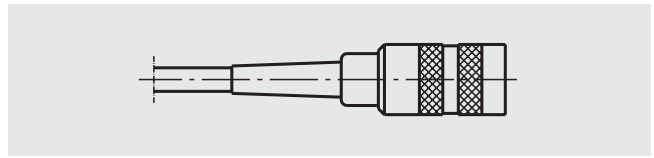

- **Lemosa connector size 1 S (male)**
- **Lemosa connector size 2 S (male)**

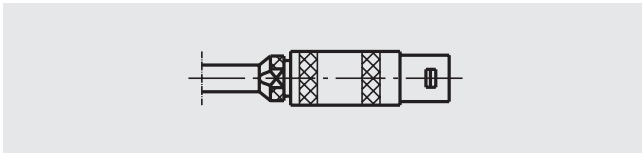

- **Lemosa coupling size 1 S (female)**
- **Lemosa coupling size 2 S (female)**

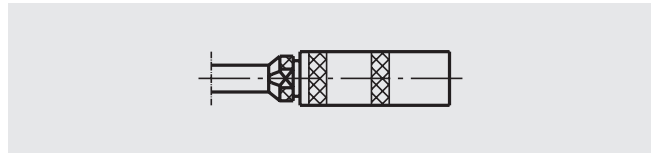

- **Standard thermo connector 2-pin (male)**
- **Miniature thermo connector 2-pin (male)**

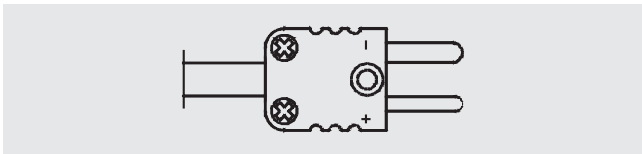

- **Standard thermo connector 2-pin (female)**
- **Miniature thermo connector 2-pin (female)**

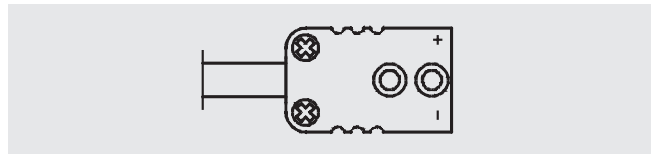

- **Spade lugs**

(not suitable for versions with bare connecting wires)

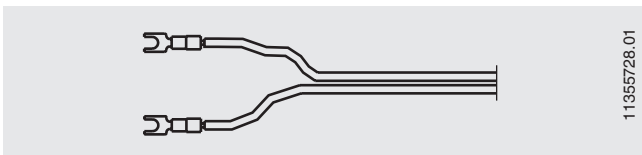

Other connector variants (sizes) on request.

## Electrical connection

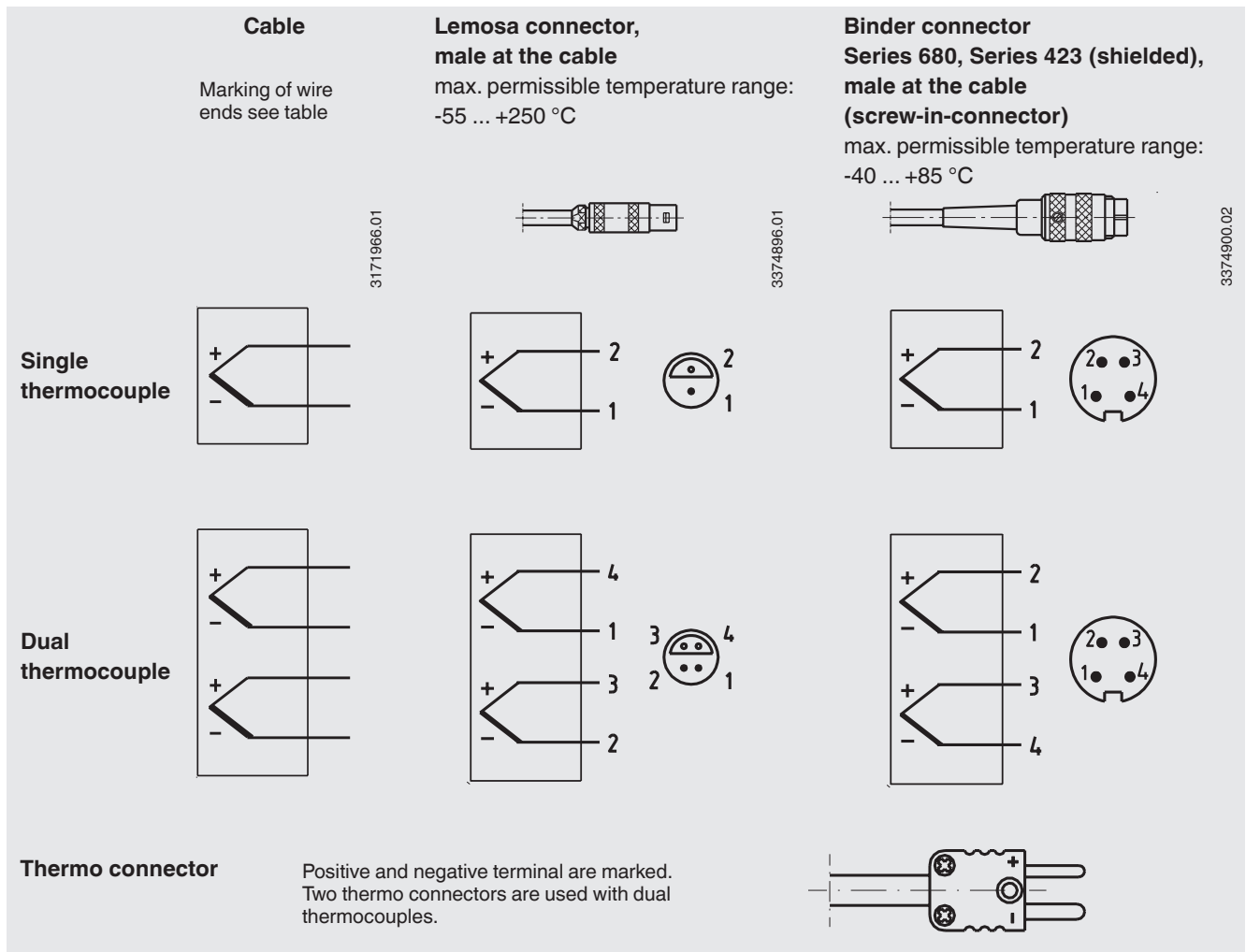

Other coupler connectors and pin assignments on request.

### Colour code of cable

Sensor type	Standard	Positive	Negative
K	IEC 60584	Green	White
J	IEC 60584	Black	White
E	IEC 60584	Violet	White
T	IEC 60584	Brown	White
N	IEC 60584	Pink	White

For further information on colour codes see Technical information IN 00.23 at [www.wika.com](http://www.wika.com).

## Certificates (option)

Certification type	Measuring accuracy	Material certificate
2.2 Test report	x	x

Other certificates on request.

### Ordering information

Model / Bayonet version / Explosion protection / Sensor tip version / Probe diameter and length / Probe version / Bayonet cap material / Measuring element / Temperature range / Sheath, raw material / Connection cable, sheath / Lead end version / Certificates / Options

© 01/2016 WIKA Alexander Wiegand SE & Co. KG, alle Rechte vorbehalten.  
Die in diesem Dokument beschriebenen Geräte entsprechen in ihren technischen Daten dem derzeitigen Stand der Technik.  
Änderungen und den Austausch of Werkstoffen behalten wir uns vor.

