

# Capsule pressure gauge, stainless steel

## For the process industry, high overload safety

### Model 632.51, NS 100 and 160

WIKA data sheet PM 06.06



for further approvals,  
see page 6

#### Applications

- Pressure measurement at very low pressures
- For gaseous, aggressive media, also in aggressive environments
- Robust design and ingress protection IP54, suitable for outdoor use

#### Special features

- High overload safety up to 50 x full scale value
- Scale ranges from 0 ... 2.5 mbar
- Measuring chamber protected against unauthorised intervention
- Low measured error and influence on function from medium pollution



Capsule pressure gauge, model 632.51

#### Description

These capsule pressure gauges are used when extremely-low pressures must be displayed on site. The instruments can be overloaded up to 50 times the full scale value without any problems.

The large effective area of the two welded, radially corrugated diaphragms of the capsule element allows the reliable measurement of the smallest pressures. These measuring instruments, made entirely of stainless steel, are suitable for gaseous, aggressive media.

The capsule pressure gauge of model 632.51 has been qualified and manufactured in accordance with EN 837-3.

## Functionality

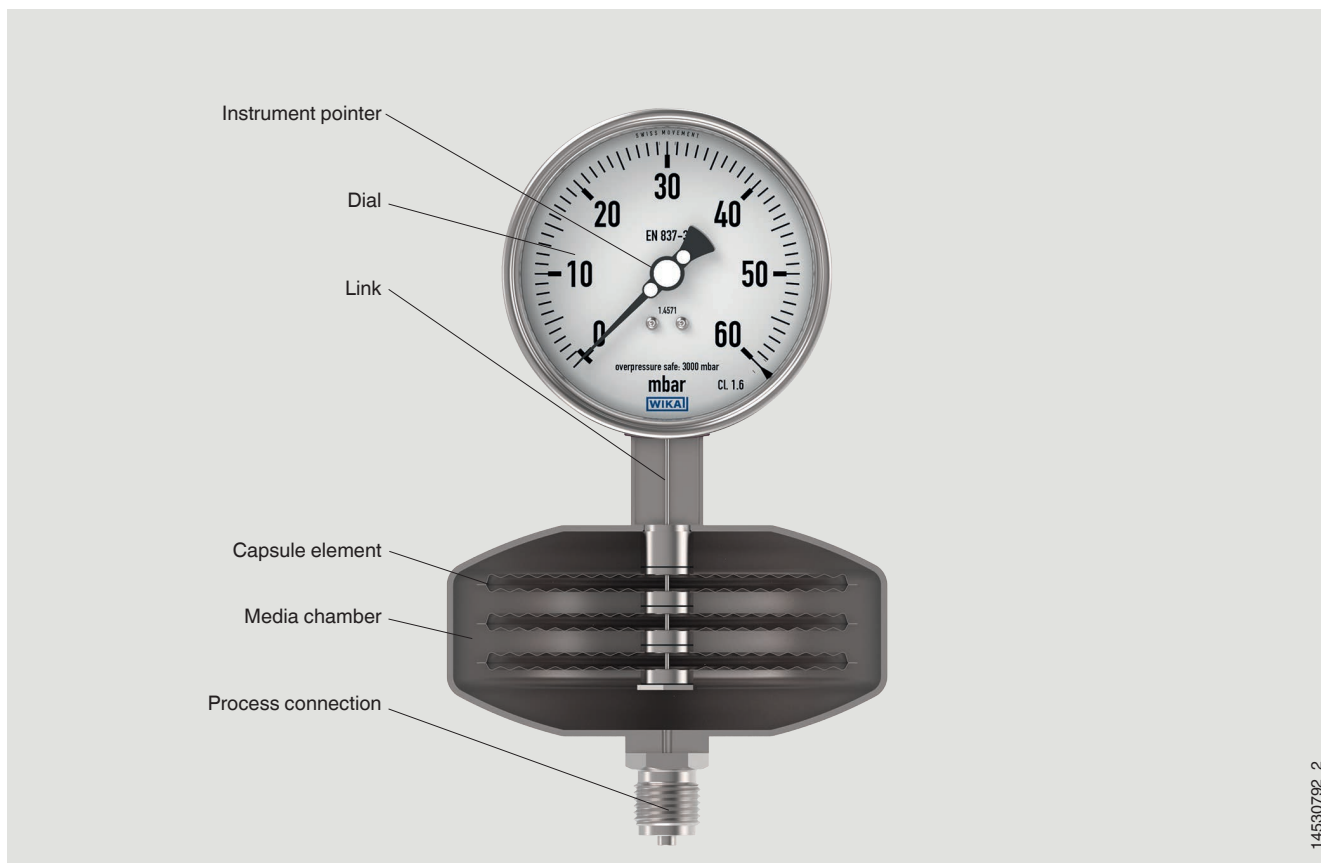

The pressure element, the capsule element, consists of two radially corrugated diaphragms welded at the edge. This increases the effective area of the pressure element compared to diaphragm pressure gauges. Capsule pressure gauges are therefore able to measure extremely low pressures.

The pressure element shown above consists of 3 capsule elements. The link passes through the centre and is attached to the lower capsule element so that unhindered deformation is possible in the media chamber. The pressure element is pressurised from the outside. This results in stroke movements - the measuring travel itself. The measuring travel of the pressure element is transmitted to the movement via the link and displayed by the instrument pointer on the dial.

### Overload safety

The capsule element can, through the mutually supporting surfaces of both halves of the capsule element, withstand up to 50 times overload. With a scale range of 0 ... 2.5 mbar, a short-term overpressure of up to 125 mbar is not problematic; the accuracy is not affected.

## Specifications

Basic information	
<b>Standard</b>	
Diaphragm and capsule pressure gauges	EN 837-3
→ For information on the "Selection, installation, handling and operation of pressure gauges", see Technical information IN 00.05.	
<b>Nominal size (NS)</b>	<ul style="list-style-type: none"> <li>■ Ø 100 mm [4"]</li> <li>■ Ø 160 mm [6"]</li> </ul>
<b>Window</b>	Laminated safety glass
<b>Case</b>	Safety level "S1" per EN 837-1: With blow-out device
Material	<ul style="list-style-type: none"> <li>■ Stainless steel 1.4301 (304)</li> <li>■ Stainless steel 1.4571 (316 Ti)</li> </ul>
<b>Ring</b>	Bayonet ring, stainless steel
<b>Movement</b>	Stainless steel

1) Only for instruments with Ex approval

2) Ingress protection IP65 for instruments with case filling

Measuring element	
<b>Type of measuring element</b>	Capsule element
<b>Materials (wetted)</b>	
Capsule element	Stainless steel 1.4571 (316 Ti)
Measuring chamber	Stainless steel 1.4571 (316 Ti)
Sealing	PTFE
Process connection	Stainless steel 1.4571 (316 Ti)

Accuracy specifications	
<b>Accuracy class</b>	<ul style="list-style-type: none"> <li>■ 1.6</li> <li>■ 1.0<sup>1)</sup></li> <li>■ 0.6<sup>1)</sup></li> </ul>
<b>Zero point setting</b>	Setting by means of adjustable pointer
<b>Temperature error</b>	On deviation from the reference conditions at the measuring system: ≤ ±0.6 % per 10 °C [≤ ±0.6 % per 18 °F] of full scale value
<b>Reference conditions</b>	
Ambient temperature	+20 °C [68 °F]

1) Application test required

### Scale ranges

Scale range	
mbar	mmH <sub>2</sub> O
0 ... 2.5	0 ... 25
0 ... 4	0 ... 40
0 ... 6	0 ... 60
0 ... 10	0 ... 100
0 ... 16	0 ... 160
0 ... 25	0 ... 250
0 ... 40	0 ... 400
0 ... 60	0 ... 600
0 ... 100	0 ... 1,000

Scale range	
inH <sub>2</sub> O	kPa
0 ... 5	0 ... 1
0 ... 10	0 ... 1.6
0 ... 15	0 ... 2.5
0 ... 20	0 ... 4
0 ... 25	0 ... 6
0 ... 30	0 ... 10
0 ... 40	

## Vacuum and +/- scale ranges

Scale range	
mbar	
-2.5 ... 0	-8 ... +8
-4 ... 0	-10 ... +6
-6 ... 0	-10 ... +15
-10 ... 0	-10 ... +30
-16 ... 0	-10 ... +50
-25 ... 0	-15 ... +10
-40 ... 0	-15 ... +25
-60 ... 0	-20 ... +5
-100 ... 0	-20 ... +20
-1 ... +5	-20 ... +40
-2 ... +4	-25 ... +15
-2 ... +8	-25 ... +75
-3 ... +3	-30 ... +30
-4 ... +2	-40 ... +20
-4 ... +6	-40 ... +60
-4 ... +12	-50 ... +10
-5 ... +1	-50 ... +50
-5 ... +5	-60 ... +40
-6 ... +10	-75 ... +25
-8 ... +2	-80 ... +20

Other scale ranges on request

Further details on: Scale ranges		
<b>Unit</b>	<ul style="list-style-type: none"> <li>■ mbar</li> <li>■ kPa</li> <li>■ mmH<sub>2</sub>O</li> <li>■ inH<sub>2</sub>O</li> </ul> Other units on request	
<b>Overload safety</b>	50 x full scale value <sup>1)</sup>	
<b>Vacuum resistance</b>	<ul style="list-style-type: none"> <li>■ Without</li> <li>■ 10 x full scale value</li> <li>■ 3 x full scale value</li> </ul>	
<b>Dial</b>		
Scale layout	<ul style="list-style-type: none"> <li>■ Single scale</li> <li>■ Dual scale</li> </ul>	
Scale colour	Single scale	Black
	Dual scale	Black/red
Material	Aluminium	
Customer-specific version	Other scales, e.g. with red mark, circular arcs or circular sectors, on request → Alternatively, adhesive label set for red and green circular arcs; see data sheet AC 08.03	
<b>Instrument pointer</b>	Adjustable pointer, aluminium, black	

1) Higher overload safety possible in certain circumstances after application test

Process connection	
<b>Standard</b>	<ul style="list-style-type: none"> <li>■ EN 837</li> <li>■ ANSI / ASME B1.20.1</li> </ul>
<b>Size <sup>1)</sup></b>	
EN 837	<ul style="list-style-type: none"> <li>■ G ½ B</li> <li>■ M20 x 1.5</li> </ul>
ANSI / ASME B1.20.1	½ NPT
<b>Materials (wetted)</b>	
Capsule element	Stainless steel 1.4571 (316 Ti)
Measuring chamber	Stainless steel 1.4571 (316 Ti)
Sealing	PTFE
Process connection	Stainless steel 1.4571 (316 Ti)

1) For further connection threads, see data sheet IN 00.10

Other process connections on request

Operating conditions	
<b>Medium temperature range</b>	+100 °C [+212 °F] maximum
<b>Ambient temperature range</b>	-20 ... +60 °C [-4 ... +140 °F]
<b>Storage temperature range</b>	-40 ... +70 °C [-4 ... 140 °F]
<b>Pressure limitation</b>	
Steady	Full scale value
Fluctuating	0.9 x full scale value
<b>Ingress protection per IEC/EN 60529</b>	IP54

## Other versions









- Version for hazardous areas (Ex h)
- Capsule pressure gauge with switch contacts; see data sheet PV 26.06
- Capsule pressure gauge with output signal, see data sheet PV 16.06
- Oil- and grease-free
- For oxygen, oil- and grease-free
- With pre-volume deflagration flame arrester <sup>1)</sup> for connection to zone 0 (EPL Ga); model 910.21; see data sheet AC 91.02

1) Only for instruments with Ex approval

## Approvals

Logo	Description	Region
-	<b>CRN</b> Safety (e.g. electr. safety, overpressure, ...)	Canada

### Optional approvals

Logo	Description	Region
 	<b>EU declaration of conformity</b> ATEX directive Hazardous areas Gas II 2G h IIC T6 ... T1 Gb X Dust II 2D h IIC T85°C ... T450°C Db X	European Union
	<b>EAC</b> Hazardous areas	Eurasian Economic Community
	<b>Ex Ukraine</b> Hazardous areas	Ukraine
	<b>PAC Russia</b> Metrology, measurement technology	Russia
	<b>PAC Kazakhstan</b> Metrology, measurement technology	Kazakhstan
-	<b>MChS</b> Permission for commissioning	Kazakhstan
	<b>PAC Belarus</b> Metrology, measurement technology	Belarus
-	<b>PAC Ukraine</b> Metrology, measurement technology	Ukraine
	<b>PAC Uzbekistan</b> Metrology, measurement technology	Uzbekistan
-	<b>CPA</b> Metrology, measurement technology	China

## Certificates (option)

Certificates	
<b>Certificates</b>	<ul style="list-style-type: none"> <li>■ 2.2 test report per EN 10204 (e.g. state-of-the-art manufacturing, indication accuracy)</li> <li>■ 3.1 inspection certificate per EN 10204 (e.g. material proof for wetted metal parts, indication accuracy)</li> </ul>
<b>Recommended recalibration interval</b>	1 year (dependent on conditions of use)

For approvals and certificates, see website

# Dimensions in mm [in]

Model 632.51

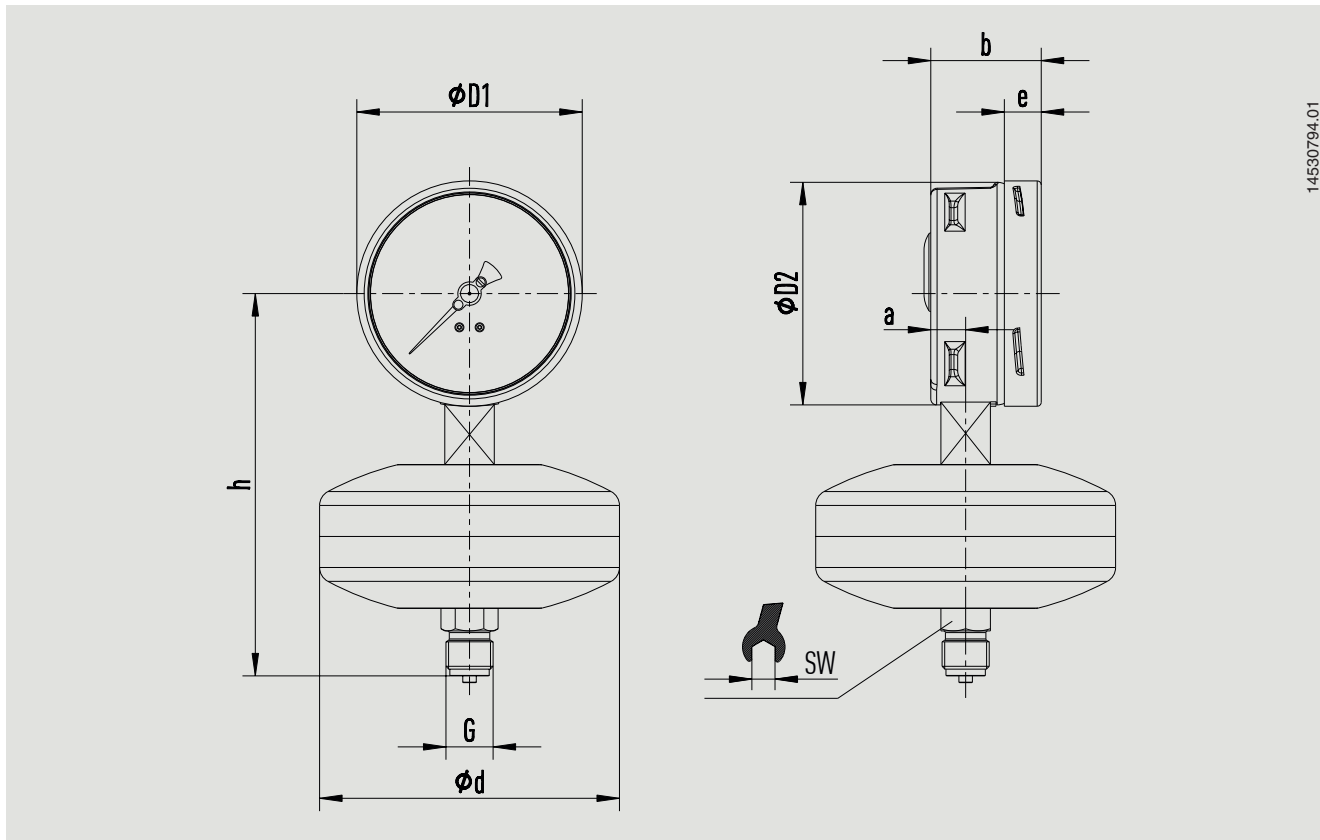

14530794.01







## Nominal size 100 [4"]

Process connection G	Dimensions in mm [in]								Weight in kg [lb]
	d	a	b	D1	D2	e	$h \pm 1$ [0.04]	SW	
G ½ B	133 [5.24]	15.5 [0.61]	49.5 [1.95]	101 [3.98]	99 [3.90]	17.5 [0.69]	170 [6.69]	22 [0.87]	1.6 [3.53]
½ NPT	133 [5.24]	15.5 [0.61]	49.5 [1.95]	101 [3.98]	99 [3.90]	17.5 [0.69]	169 [6.65]	22 [0.87]	2.1 [4.63]

## Nominal size 160 [6"]

Process connection G	Dimensions in mm [in]								Weight in kg [lb]
	d	a	b	D1	D2	e	$h \pm 1$ [0.04]	SW	
G ½ B	133 [5.24]	15.5 [0.61]	49.5 [1.95]	161 [6.34]	159 [6.26]	17.5 [0.69]	200 [7.87]	22 [0.87]	1.6 [3.53]
½ NPT	133 [5.24]	15.5 [0.61]	49.5 [1.95]	161 [6.34]	159 [6.26]	17.5 [0.69]	199 [7.83]	22 [0.87]	2.1 [4.63]

## Accessories and spare parts

Model	Description	Order number
	<b>910.33</b> Adhesive label set for red and green circular arcs → See data sheet AC 08.03	-
	NS 100 [4"]	14238945
	NS 160 [6"]	14228352
	<b>910.17</b> Sealings → See data sheet AC 09.08	On request
	<b>910.14</b> Connection adapters for pressure measuring instruments → See data sheet AC 09.05	On request
	<b>910.15</b> Syphons → See data sheet AC 09.06	On request
	<b>IV20, IV21</b> Block-and-bleed valve → See data sheet AC 09.19	On request
	<b>IBF2, IBF3</b> Monoblock with flange connection → See data sheet AC 09.25	On request
	<b>910.16</b> Mounting parts for wall and pipe mounting Instrument mounting bracket and adapter piece → See data sheet AC 09.07	On request

### Ordering information

Model / Nominal size / Scale range / Process connection / Options

© 08/2009 WIKA Alexander Wiegand SE & Co. KG, all rights reserved.  
 The specifications given in this document represent the state of engineering at the time of publishing.  
 We reserve the right to make modifications to the specifications and materials.

