

Mechanical mounting

For WIKA pressure sensors and WIKA pressure switches

WIKA data sheet IN 00.14

Applications

- For fastening and sealing of a WIKA pressure sensor
- For fastening and sealing of a WIKA pressure switch

Versions

- Standard process connections
- Flush process connections
- UHP process connections
- Hygienic process connections

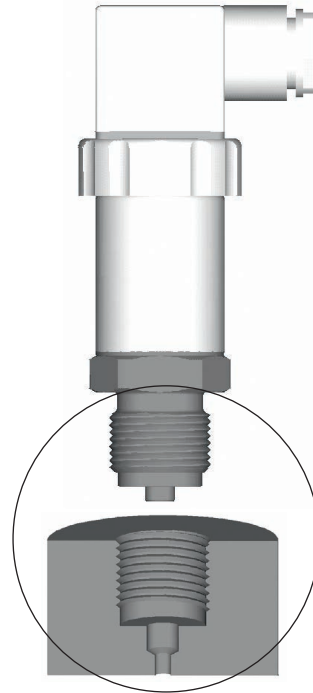

Description

WIKA offers measuring instruments with a variety of process connections in order to meet diverse customer-specific application requirements.

The customer must provide an appropriate tapped hole when installing the pressure sensor or pressure switch. This receives the WIKA pressure measuring sensor or the WIKA pressure switch.

When selecting the appropriate tapped hole, the process connection is just as critical as the thread type of the process connection and the use of the sealing. Process connections are basically divided into standard and flush process connections.

Thread types

WIKA offers process connections with various thread types which are used in numerous applications worldwide.

Types of sealing

Depending on the process connection and the medium, different sealings and sealing materials can be used. Depending on the pressure connection, the location of the sealing varies (→ For notes on sealings, see WIKA data sheet AC 09.08).

You can find further information below. Some tapped holes are available from WIKA as welding sockets. They can be ordered with the specified WIKA order number.

Making the mechanical connection

Requirements for the mounting point

The mounting point must meet the following conditions:

- The sealing faces at the pressure sensor and the measuring locations always have to be clean.
- Remove any protective cap and/or Mylar or protective foil not until shortly before installation.
- Permissible ambient temperatures remain within the performance limits of the measuring instrument. Consider possible restrictions on the ambient temperature range caused by mating connectors used.

Mechanical mounting:

1. Prior to commissioning, the pressure sensor must be subjected to a visual inspection.
Leaking liquid is indicative of damage.
2. Seal the sealing face (→ see “Sealing variants”).
3. At the mounting point, screw the pressure sensor in hand-tight.
4. When screwing in, do not cross the threads.
5. Only ever screw in, or unscrew, the instrument via the spanner flats. Never use the case as a working surface (→ see “Spanner flats”).
6. Tighten the pressure sensor with a torque spanner using the spanner flats.
The correct torque depends on the mounting point (e.g. material and shape).

Only use the pressure sensor if it is in perfect condition with respect to safety.

Only use original accessories. For accessories, see data sheet for the respective pressure sensor or pressure switch.

Additional notes for cooling element

For heat dissipation, the cooling element must not be insulated.

Additional notes for flush process connections

- Check the diaphragm for damage.
- During installation, ensure that the diaphragm is not damaged.

Additional notes for UHP process connections (models WUC-10 and WUC-15)

- For VCR®-compatible connections, the union nut/pressure screw or fitting must be tightened beyond the hand-tight position (depending on the sealings used) using a 1/8 or 1/4 turn.
- For weld-in connections, the flow of argon during the welding process is recommended for cooling.

Rework

1. The zero point must be adjusted, if necessary (→ see operating instructions).
2. Check all mechanical connections (threaded connections, welds) for leak tightness using a suitable test (e.g. helium leak test).
3. Switch the gas flow on and off at least 10 times to remove any particles that may have entered during installation. The flow rate of the gas should correspond to the subsequent process flow.

Additional information on the mounting of G1 hygienic and TRI-CLAMP® process connections

- Never loosen sealed filling screws on the measuring instrument.
- For installation, in accordance with the fitting and flange standards the appropriate fastenings, such as screws, nuts or clamp rings, must be used.
- For flange mounting, only use sealings with a sufficiently large inner diameter and centre them. Contact with the diaphragm leads to measuring deviations.
- When using a welding socket, position this so that the hole for leakage detection points downwards. Weld the welding socket flush with the inner wall of the vessel and grind down. The surface roughness of the ground surfaces must be $Ra \leq 0.8 \mu\text{m}$.
- When using soft or PTFE sealings, observe the instructions of the sealing manufacturer, particularly with regard to tightening torque and load cycles.

Spanner flats

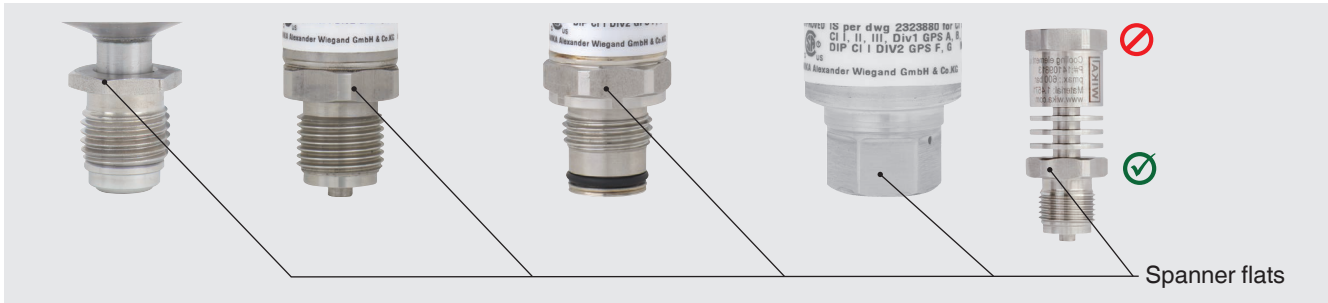

Sealing variants

Parallel threads

For sealing, use flat gaskets, lens-type sealing rings or WIKA profile sealings at the sealing face ①.

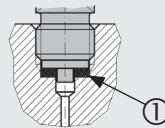

per EN 837

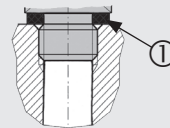

per DIN EN ISO 1179-2
(formerly DIN 3852-E)

Tapered threads

For sealing, the thread is wound with additional sealing material, e.g. PTFE tape.

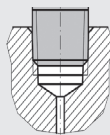

NPT, R and PT

→ For information on sealings, see WIKA data sheet AC 09.08 at www.wika.com.

Versions

Dimensions of the process connections in mm [in]



For flush process connections, see table on page 7.

The tapped holes are only shown for WIKA-specific threads. For all other tapped holes, observe the applicable standards.

Non-flush process connections

Standard	Thread	Dimensions (process connection at instrument) in mm [in]	Sketch (process connection at instrument)
ANSI/ASME B1.20.1	1/8 NPT	G: 1/8 NPT	
		L1: 10 [0.39]	
	1/4 NPT	G: 1/4 NPT	
		L1: 13 [0.51]	
	1/2 NPT	G: 1/2 NPT	
		L1: 19 [0.75]	
	1/4 NPT, female thread (for models A-10 and S-20)	G: 1/4 NPT-I	
		D1: 25 [0.98]	
		L1: 14 [0.55]	
	1/4 NPT, female thread (for model O-10)	G: 1/4 NPT-I	
D1: 19 [0.75]			
L1: 17 [0.67]			
1/4 NPT, female thread (for models C-10, E-10, F-20, N-10, P-30 and S-10)	G: 1/4 NPT-I		
	D1: 25 [0.98]		
	L1: 10 [0.39]		
DIN 16288	M12 x 1.5	G: M12 x 1.5	
		L1: 13 [0.51]	
	M20 x 1.5	G: M20 x 1.5	
		L1: 20 [0.79]	
DIN EN ISO 1179-2 (formerly DIN 3852-E)	G 1/4 A	G: G 1/4 A	
		L1: 14 [0.55]	
	G 1/2 A	G: G 1/2 A	
		L1: 17 [0.67]	
	M14 x 1.5	G: M14 x 1.5	
		L1: 14 [0.55]	

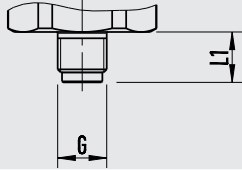
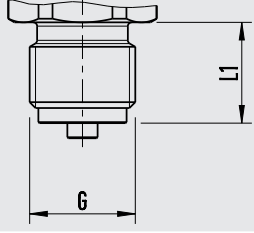
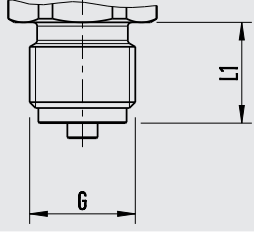
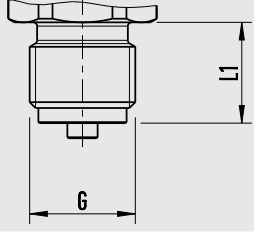
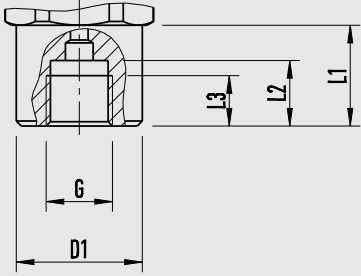
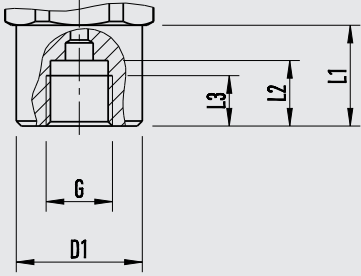
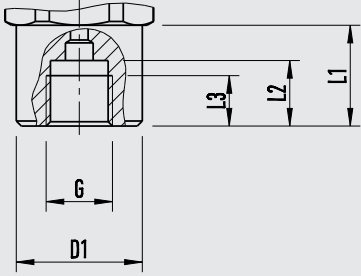
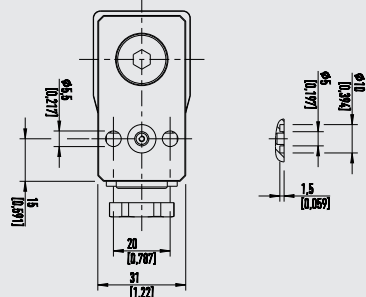
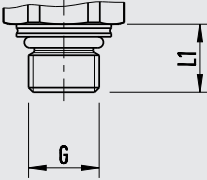
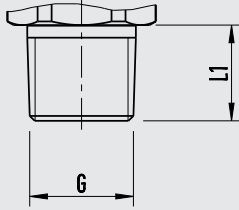
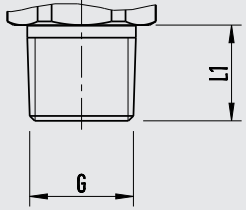
Standard	Thread	Dimensions (process connection at instrument) in mm [in]	Sketch (process connection at instrument)
EN 837	G 1/8 B	G: G 1/8 B	
		L1: 10 [0.39]	
	G 1/4 B	G: G 1/4 B	
		L1: 13 [0.51]	
	G 3/8 B	G: G 3/8 B	
		L1: 16 [0.63]	
	G 1/2 B	G: G 1/2 B	
		L1: 20 [0.79]	
	G 1/4, female thread (for models A-10, PSD-30, PSD-4 and S-20)	G: G 1/4-l	
		D1: Ø 25 [0.98]	
		L1: 20 [0.79] L2: 13 [0.51] L3: 10 [0.39]	
	G 1/4, female thread (for model S-10)	G: G 1/4-l	
D1: Ø 17.5 [0.69]			
L1: 19.5 [0.77] L2: 13 [0.51] L3: 10 [0.39]			
G 1/4, female thread (for model O-10)	G: G 1/4-l		
	D1: Ø 19 [0.75]		
	L1: 17 [0.67] L2: 13 [0.51] L3: 10 [0.39]		
-	Flange connection	Diameter 5 mm	
ISO 6149-2	M14 x 1.5	G: M14 x 1.5	
		L1: 13.5 [0.53]	
ISO 7	R 1/4	G: R 1/4	
		L1: 13 [0.52]	
	R 3/8	G: R 3/8	
L1: 15 [0.59]			
R 1/2	G: R 1/2		
	L1: 19 [0.75]		

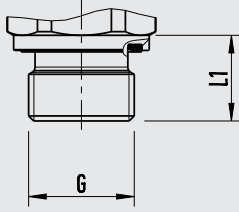
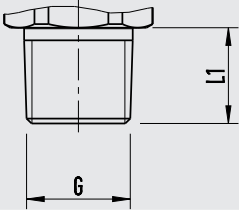
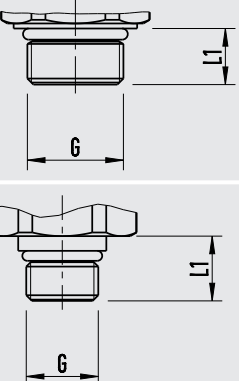
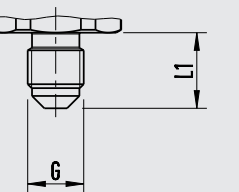
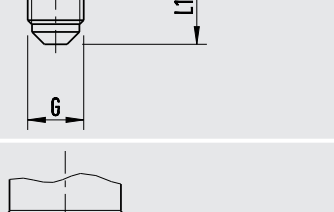
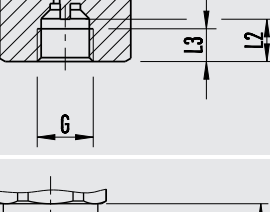
Standard	Thread	Dimensions (process connection at instrument) in mm [in]	Sketch (process connection at instrument)	
JIS B2351-1	G ¼ x 10, form O with collar	G: G ¼ x 10 L1: 10 [0.39]		
	G ¾, form O with collar	G: G ¾ L1: 12 [0.47]		
KS B 0222	PT ¼	G: PT ¼ L1: 13 [0.52]		
	PT ¾	G: PT ¾ L1: 15 [0.59]		
	PT ½	G: PT ½ L1: 19 [0.75]		
SAE J514	¾-16 UNF-2A O-ring BOSS	G: ¾-16 UNF-2A L1: 11.13 [0.44]		
	⅞-20 UNF-2A O-ring BOSS	G: ⅞-20 UNF-2A L1: 12.06 [0.48]		
	⅞-18 UNF-2A O-ring BOSS	G: ⅞-20 UNF-2A L1: 12.85 [0.51]		
	⅞-20 UNF-2A 74°	G: ⅞-20 UNF-2A cone 74° L1: 15 [0.59]		
SAE J513 compatible	⅞-20 UNF-2A 90°	G: ⅞-20 UNF-2A cone 90° L1: 15 [0.59]		
SAE J515 compatible	⅞-20 UNF-2B, Schrader connection	G: ⅞-20 UNF-2B L1: 16 [0.63] L2: 8.4 [0.33] L3: 6.5 [0.26]		
Ermeto compatible	G ¼, female thread (for model PSD-4)	G: G ¼-l L1: 20 [0.79] L2: 15 [0.59] L3: 12 [0.47] D1: 25 [0.98]		
		G ¼, female thread (for model TIS-20)		G: G ¼-l L1: 20 [0.79] L2: 17.5 [0.689] L3: 14 [0.55] D1: 26.5 [1.04]

14280340

Flush process connections

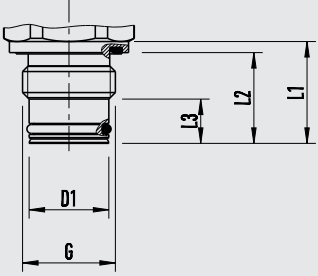
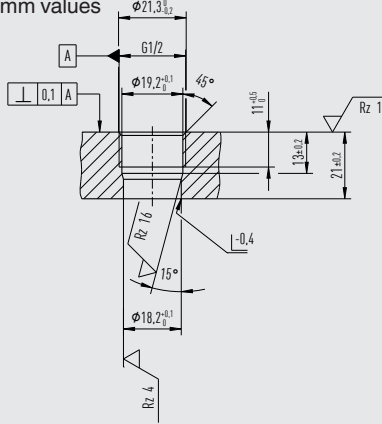
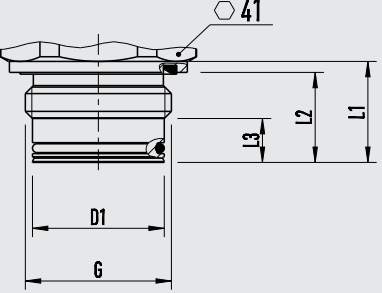
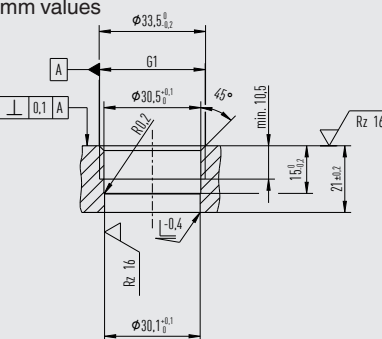
Standard	Thread	Dimensions (process connection at instrument) in mm [in]	Sketch (process connection at instrument)	Sketch (tapped hole with dimensions)
EN 837	G 1/2 B	G: G 1/2 B		<p>mm values</p> 
		D1: 18 [0.71]		L1: 23 [0.91]
	G 1 B	G: G 1 B		<p>mm values</p> 
		D1: 30 [1.18]		L1: 23 [0.91]

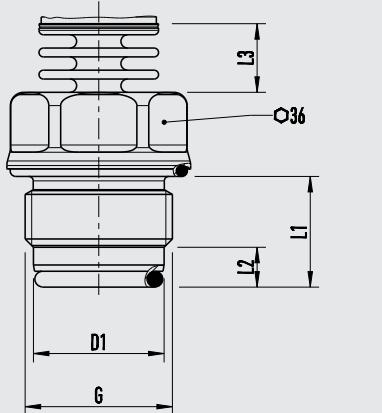
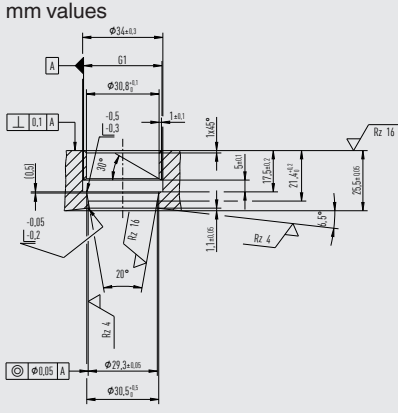
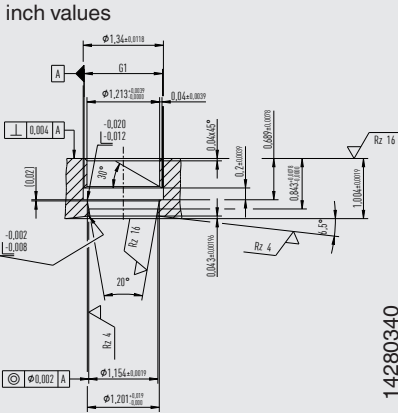
Stand- ard	Thread	Dimensions (process connection at instru- ment) in mm [in]	Sketch (process connection at instrument)	Sketch (tapped hole with dimensions)
EN 837	G 1 B hygienic	G: G 1 B (hygienic) D1: 29.5 [1.61] L1: 25 [0.98] L2: 9 [0.35] L3: 15.5 [0.61]		<p>mm values</p>  <p>inch values</p> 

14280340

UHP process connections

Thread	Sketch (process connection at instrument)
¼" weld stub (Max. available pressure: 300 psi)	
¼" pressure screw, rotatable VCR compatible	
¼" T-connector, weld stub	

Notes

- The sketches of the process connections shown are not to scale.
- For customer-specific versions of the pressure sensors or pressure switches, other process connections can also be used, depending on agreement. The dimensions are then part of the respective agreement and correspond to the requirements of the customer's specification.

Process connections G 1 hygienic and TRI-CLAMP®

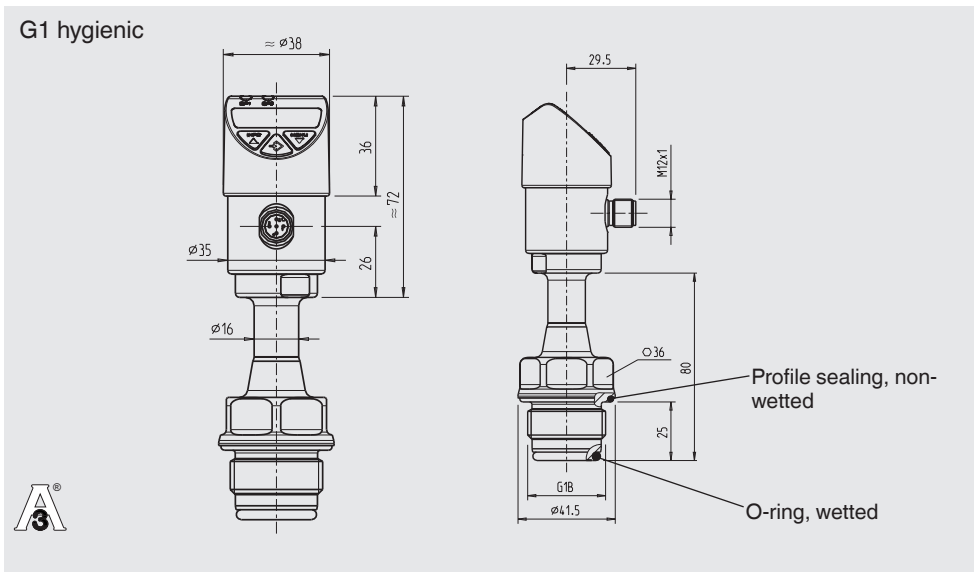

Suitable for WIKA adapter system model 910.61

For dimensions of the appropriate process adapters and welding sockets see data sheet AC 09.20

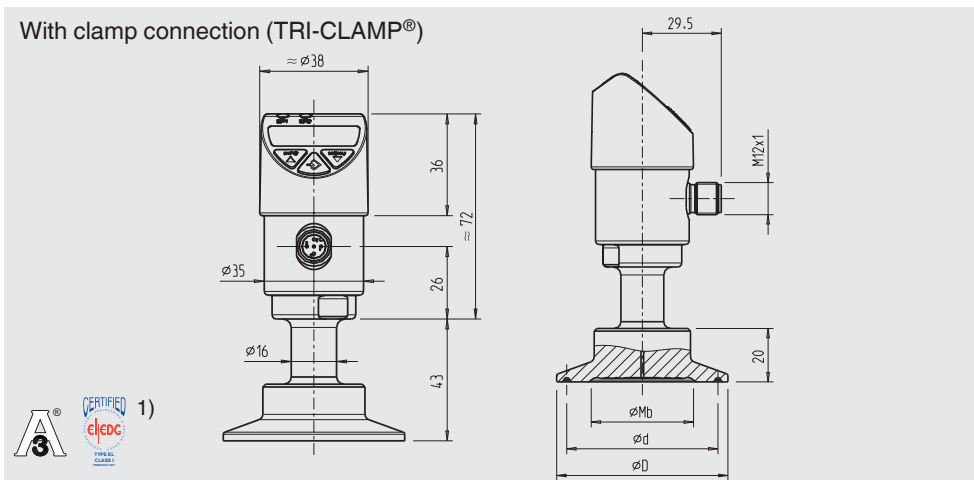

Version	Dimensions in mm			
	Ø Mb	Ø d	Ø D	
Clamp connection (TRI-CLAMP®) 2)	1 ½" suitable for clamp connections per ASME BPE 1 ½", DIN 32676 row A DN 40, row C DN 1 ½", BS 4825 part 3 DN 38.1	32	43.5	50.5
	2" suitable for clamp connections per ASME BPE 2", DIN 32676 row A DN 50, row B DN 42.4 and 48.3, row C DN 2", BS 4825 part 3 DN 50.8	40	56.6	64

1) EHEDG conformity only in combination with the clamp connection with a T-ring seal from Combifit Metaalbewerking B.V.

2) For maximum pressure range consider pressure rating of clamp.

© 04/2003 WIKA Alexander Wiegand SE & Co. KG, all rights reserved.
The specifications given in this document represent the state of engineering at the time of publishing.
We reserve the right to make modifications to the specifications and materials.

